



**HAND TOOLS & ACCESSORIES**  
**OUTILS MANUELS ET ACCESSORIES**



# CONTENT | CONTENU

## PAGES

<b>STRIKING TOOLS - HAMMERS</b>	<b>130</b>	<b>SCRAPERS &amp; ACCESSORIES</b>	<b>200</b>
<b>STRIKING TOOLS - SLEDGE HAMMERS</b>	<b>134</b>	<b>FLOOR SCRAPERS</b>	<b>202</b>
<b>STRIKING TOOLS - AXES &amp; MAULS</b>	<b>138</b>	<b>WOOD PLANES &amp; SHARPENING STONES</b>	<b>204</b>
<b>REPLACEMENT HANDLES</b>	<b>141</b>	<b>WOOD, BRICK CHISELS &amp; PUNCHES</b>	<b>206</b>
<b>WRECKING, NAIL PULLERS &amp; PRY BARS</b>	<b>142</b>	<b>FILES</b>	<b>212</b>
<b>SCREWDRIVERS &amp; NUT DRIVERS</b>	<b>144</b>	<b>WIRE BRUSHES</b>	<b>214</b>
<b>DRIVE BITS &amp; ACCESSORIES</b>	<b>154</b>	<b>CLAMPS, VISES &amp; VISE GRIPS</b>	<b>216</b>
<b>TORQUE &amp; HEX KEY SET</b>	<b>156</b>	<b>TUBE CUTTERS &amp; ACCESSORIES</b>	<b>224</b>
<b>SOCKET &amp; DRIVES SETS</b>	<b>159</b>	<b>PEX TOOLS &amp; ACCESSORIES</b>	<b>226</b>
<b>RATCHET &amp; WRENCHES</b>	<b>166</b>	<b>STRIKING TOOLS</b>	<b>229</b>
<b>PIPE WRENCHES</b>	<b>171</b>	<b>REPLACEMENT HANDLES</b>	<b>231</b>
<b>PLIERS</b>	<b>172</b>	<b>WRECKING, NAIL PULLERS &amp; PRY BARS</b>	<b>232</b>
<b>PLIERS SETS</b>	<b>178</b>	<b>SCREWDRIVERS SETS</b>	<b>233</b>
<b>LOCKING PLIERS</b>	<b>180</b>	<b>CLAMPS &amp; VISE GRIPS</b>	<b>234</b>
<b>MIXED TOOL SETS</b>	<b>182</b>	<b>CLAMPS &amp; VISE GRIPS</b>	<b>235</b>
<b>SNAP RING PLIER SETS</b>	<b>183</b>	<b>PLIERS &amp; AVIATION SNIPS</b>	<b>236</b>
<b>AVIATION TIN SNIPS</b>	<b>184</b>	<b>HAND SAWS</b>	<b>238</b>
<b>BOLT CUTTERS</b>	<b>186</b>	<b>UTILITY KNIVES &amp; ACCESSORIES</b>	<b>240</b>
<b>HAND SAWS</b>	<b>187</b>	<b>SCRAPERS &amp; WOOD PLANES</b>	<b>244</b>
<b>BOW &amp; COPING SAWS</b>	<b>189</b>	<b>FILES, CHISELS &amp; CLAMPS</b>	<b>246</b>
<b>HACKSAW &amp; HACKSAW BLADES</b>	<b>191</b>		
<b>UTILITY KNIVES - FOLDING</b>	<b>194</b>		
<b>UTILITY KNIVES - SNAP-OFF BLADE</b>	<b>195</b>		
<b>UTILITY KNIVES - RETRACTABLE BLADE</b>	<b>196</b>		
<b>UTILITY KNIFE BLADES</b>	<b>199</b>		

claw Hammer



ITEM #	DESCRIPTION	SIZE	MATERIAL/FINISH/HANDLE	FEATURES	INNER	MASTER	UPC CODE	BARCODE
<b>705102</b>	claw Hammer	8oz	Wooden Handle	Varnised Wood	6	48	621457051027	
<b>705103</b>	claw Hammer	16oz	Wooden Handle	Varnised Wood	6	36	621457051034	
<b>396619</b>	Claw Hammer	8oz	Tubular Steel	Vinyl Grip	6	36	773544966193	
<b>705123</b>	claw Hammer	16oz	Tubular Steel Handle	Rubber Grip	6	36	621457051232	
<b>705143</b>	claw Hammer	16oz	Fiberglass Handle	Rubber Grip	6	36	621457051430	
<b>705081</b>	claw Hammer	16oz	Solid Steel	Vinyl Grip	6	24	621457050815	
<b>708575</b>	claw Hammer	10oz	All Steel Handle	Stubby	6	48	710807	
<b>396606</b>	Claw Hammer	16oz	Hard Wood	Varnished Wood	6	36	773544966063	

Framing Hammer



A framing hammer is essentially the same as a regular claw hammer except: it is longer, heavier, it may have a ridged, milled hammer face, it may also have a flatter claw.



ITEM #	SIZE	INNER	MASTER	UPC CODE	BARCODE
<b>705083</b>	22oz	6	24	621457050839	
<b>705184</b>	22oz	6	24	621457051843	
<b>155507</b>	24oz	6	24	20861555075	

Ripping Hammer



A rip hammer is an all around utility tool capable of dozens of tasks besides driving nails. Rip hammers have a straight claw instead of a curved claw.



ITEM #	SIZE	INNER	MASTER	UPC CODE	BARCODE
<b>705082</b>	16oz	6	24	621457050822	
<b>155506</b>	20oz	6	24	20861555068	

**THE Workbench<sup>SM</sup> Series**

Fiberglass Handle



A Ball Pein Hammer is a hammer with two ends on the head, one that is round and the other flat. Sometimes called a machinist's hammer, a ball pein is a good choice for working with metal. Its steel head is harder than that of a claw hammer, so is less likely to chip on impact. Ball pein hammers are commonly used to drive cold chisels, set rivets, and bend and shape metal.



ITEM #	DESCRIPTION	SIZE	MATERIAL/FINISH/HANDLE	FEATURES	INNER	MASTER	UPC CODE	BARCODE
705191	Ball Pein Hammers	4oz	All Steel Handle	Rubber Grip	6	60	621457051911	
705192	Ball Pein Hammers	8oz	Fiberglass Handle	Rubber Grip	6	60	621457051928	
705193	Ball Pein Hammers	12oz	Fiberglass Handle	Rubber Grip	5	30	621457051935	
705194	Ball Pein Hammers	16oz	Fiberglass Handle	Rubber Grip	6	24	621457051942	
705195	Ball Pein Hammers	24oz	Fiberglass Handle	Rubber Grip	6	12	621457051959	
705196	Ball Pein Hammers	32oz	Fiberglass Handle	Rubber Grip	6	12	621457051966	
705197	Ball Pein Hammers	40oz	Fiberglass Handle	Rubber Grip	6	12	621457051973	
705198	Ball Pein Hammers	48oz	Fiberglass Handle	Rubber Grip	6	12	621457051980	
705189	Ball Pein Hammers	12oz	Fiberglass Handle	Stubby	6	48	621457051898	

**THE Workbench<sup>SM</sup> Series**

5pc Ball Pein Hammer Set

**THE Workbench<sup>SM</sup> Series**

Brass Hammers



Heavy-Duty  
Fiberglass Handle  
Vinyl Grip



- Double-faced,
- Solid brass head
- Fiberglass Handle
- Vinyl Grip



ITEM #	SIZE	INNER	MASTER	UPC CODE	BARCODE
705190	5pc	1	4	621457051904	

ITEM #	SIZE	INNER	MASTER	UPC CODE	BARCODE
705504	1lbs	6	24	621457055049	
705505	1.5lbs	6	24	621457055056	
705506	2lbs	6	12	621457055063	
705507	3lbs	6	12	621457055070	

Machinist Hammers

THE **Workbench**™ Series



Heavy-Duty  
Fiberglass Handle  
Vinyl Grip

ITEM #	SIZE	INNER	MASTER	UPC CODE	BARCODE
705403	300g	8	48	621457054035	
705405	500g	6	36	621457054059	
705408	800g	6	24	621457054080	
705409	1000g	6	24	621457054097	

Roofing Hammer

THE **Workbench**™ Series



All Steel  
Vinyl Grip

ITEM #	SIZE	INNER	MASTER	UPC CODE	BARCODE
705085	24oz	6	24	621457050853	

Brick Layer Hammer

THE **Workbench**™ Series



All Steel  
Vinyl Grip

ITEM #	SIZE	INNER	MASTER	UPC CODE	BARCODE
705086	24oz	6	24	621457050860	

Brick Layer Hammer

THE **Workbench**™ Series



Fiberglass Handle  
Rubber Grip

ITEM #	SIZE	INNER	MASTER	UPC CODE	BARCODE
705339	24oz	1	24	621457053397	



Brick Layer Hammer

**Goldblatt**  
SINCE 1885



- Drop forged from high grade tool steel
- Larger Hammer face and wider blade for any tough job
- Well balanced design
- Selected contoured Hardwood handle

ITEM #	SIZE	INNER	MASTER	UPC CODE	BARCODE
G06993	20oz	1	3	84389069933	

Welders Hammer



- High carbon steel chipping hammer for maximum strength
- Black all purpose tool for welding
- Shock proof handle with loop for belt
- Tempered chisel on one end and point on the other

ITEM #	SIZE	INNER	MASTER	UPC CODE	BARCODE
705501	500g	6	48	621457055018	

**THE Workbench** Series

Drywall Hammer



- All Steel w/Vinyl Grip
- Hachet end has a notch for pulling nails
- Ergonomic anti-vibration handle minimizes vibration and shock at impact

ITEM #	SIZE	INNER	MASTER	UPC CODE	BARCODE
705084	12oz	6	24	621457050846	

Auto body Repair Hammer



**Hickory Handle**

- Suitable for all body repair and panel beating requirements.
- Heat treated, drop forged steel for strength and durability.

ITEM #	SIZE	INNER	MASTER	UPC CODE	BARCODE
705500		6	36	621457055001	

**Goldblatt**  
SINCE 1885

Drywall Hammer



- Solid forged steel shaft with fully polished milled face
- Hachet end has a notch for pulling nails
- Ergonomic anti-vibration handle minimizes vibration and shock at impact
- Ideal for installing drywall or gypsum board

ITEM #	SIZE	INNER	MASTER	UPC CODE	BARCODE
G05027	14oz	1	4	84389050276	

Sledge Hammers -  
Fiberglass Handle



Durable fiberglass handle provides optimum striking leverage

14" Handle



Double face sledge hammer  
Drop forged, heat treated, black enameled head with polished faces is designed for maximum life



Fiberglass Handle  
Rubber Grip

36" Handle

ITEM #	DESCRIPTION	HANDLE LENGTH	MATERIAL/FINISH/HANDLE	WEIGHT	INNER	MASTER	UPC CODE	BARCODE
132380	Sledge Hammers	14"	Fiberglass Handle	2Lb	1	24	20861323803	
132383	Sledge Hammers	14"	Fiberglass Handle	3Lb	1	12	20861323834	
132390	Sledge Hammers	16"	Fiberglass Handle	4Lb	1	12	20861323902	
132406	Sledge Hammers	36"	Fiberglass Handle	6Lb	1	6	20861324060	
132413	Sledge Hammers	36"	Fiberglass Handle	8Lb	1	4	20861324138	
132420	Sledge Hammers	36"	Fiberglass Handle	10Lb	1	4	20861324206	
132437	Sledge Hammers	36"	Fiberglass Handle	12Lb	1	4	20861324374	

Sledge Hammers - Wood Handle



Varnished hickory handle absorbs shock well

36" Handle



Double face sledge hammer  
Drop forged, heat treated, black enameled head with polished faces is designed for maximum life

ITEM #	DESCRIPTION	HANDLE LENGTH	MATERIAL/FINISH/HANDLE	WEIGHT	INNER	MASTER	UPC CODE	BARCODE
132470	Sledge Hammers	36"	Fiberglass Handle	6lbs	1	4	20861324701	
132475	Sledge Hammers	36"	Hickory Handle	8lbs	1	4	20861324756	
132480	Sledge Hammers	36"	Hickory Handle	10lbs	1	4	20861324800	
132485	Sledge Hammers	36"	Hickory Handle	12lbs	1	4	20861324855	

Club Hammers



Double face Club hammer  
Drop forged, heat treated,  
black enameled head with  
polished faces is designed  
for maximum life

Durable fiberglass handle  
provides optimum striking  
leverage

For Masonry Work

10" Handle

Fiberglass Handle  
Rubber Grip

ITEM #	DESCRIPTION	HANDLE LENGTH	MATERIAL/FINISH/HANDLE	WEIGHT	INNER	MASTER	UPC CODE	BARCODE
155616	Club Hammers	10"	Fiberglass Handle	2.5lbs	6	12	20861556164	
155512	Club Hammers	10"	Fiberglass Handle	3lbs	6	12	20861555129	
155618	Club Hammers	10"	Fiberglass Handle	4lbs	6	12	20861556188	

2pc Sledge Hammers Sets



Double face sledge hammer  
Drop forged, heat treated,  
black enameled head with  
polished faces is designed  
for maximum life

**705301**

Durable fiberglass handle  
provides optimum striking  
leverage

Fiberglass Handle  
Rubber Grip



Fiberglass Handle  
Rubber Grip

**705302**

ITEM #	DESCRIPTION	HANDLE LENGTH	MATERIAL/FINISH/HANDLE	WEIGHT	INNER	MASTER	UPC CODE	BARCODE
705301	Sledge Hammers Set	14" & 36"	Fiberglass Handle	3lbs, 8lbs	1	4	621457053014	
705302	Sledge & cross Pein Set	12" & 14"	Fiberglass Handle	3lbs, 3lbs	1	4	621457053021	

Dead Blow Hammers



**Steel Structure Completely Encased In Polyurethane**

ITEM #	DESCRIPTION	WEIGHT	MATERIAL/FINISH/HANDLE	FEATURES	INNER	MASTER	UPC CODE	BARCODE
705012	Dead Blow Hammers	1lbs	Steel Structure	Encased in Polyurethane	10	20	621457050129	
705013	Dead Blow Hammers	1.5lbs	Steel Structure	Encased in Polyurethane	5	20	621457050136	
705014	Dead Blow Hammers	2lbs	Steel Structure	Encased in Polyurethane	10	20	621457050143	
155725	Dead Blow Hammers	3lbs	Steel Structure	Encased in Polyurethane	6	18	20861557253	
155728	Dead Blow Hammers	4oz	Steel Structure	Encased in Polyurethane	1	12	20861557284	

Rubber Mallets



Fiberglass Handle  
Vinyl Grip

705020  
705022



Wood Handle  
Industrial Quality

155707



Fiberglass Handle  
Rubber Grip

155706



Wood Handle  
Industrial Quality

705034

ITEM #	DESCRIPTION	WEIGHT	MATERIAL HANDLE	FEATURES	INNER	MASTER	UPC CODE	BARCODE
705020	Rubber Mallet -White	16oz	Fiberglas Handle	Rubber Grip	10	40	621457050204	
705022	Rubber Mallet -White	24oz	Fiberglas Handle	Rubber Grip	10	30	621457050228	
155707	Rubber Mallet -White	24oz	Wood Handle	Wood	6	24	20861557079	
155706	Rubber Mallet -White	32oz	Fiberglas Handle	Rubber Grip	6	24	20861557062	
705034	Rubber Mallet - White	32oz	Wood Handle	Wood			621457050341	

Rubber Mallet - Black & White



Varnished hickory handle  
absorbs shock wel

396552  
396553



Varnished hickory handle  
absorbs shock weli

396562  
396563

ITEM #	DESCRIPTION	WEIGHT	MATERIAL/FINISH/HANDLE	FEATURES	INNER	MASTER	UPC CODE	BARCODE
396552	Rubber Mallet Black	16oz	Wood Handle	Black	6	36	773544965523	
396553	Rubber Mallet Black	32oz	Wood Handle	Black	6	24	773544965530	
396562	Rubber Mallet White	16oz	Wood Handle	White	6	36	773544965622	
396563	Rubber Mallet White	32oz	Wood Handle	White	6	24	773544965639	

3pc Rubber Mallet Set



705028

Mallet - Stone Hammer



155716

ITEM #	DESCRIPTION	WEIGHT	MATERIAL/FINISH/HANDLE	FEATURES	INNER	MASTER	UPC CODE	BARCODE
705028	3pc Rubber Mallet Set	8, 16, 32oz	Fiberglas Handle	Rubber Grip	1	12	621457050280	
155716	Mallet - Stone Hammer	3.75lbs	Hickory Handle	Steel Head	1	10	20861557161	

Super Club Hammer



For Masonry Work

Double face sledge hammer  
Drop forged, heat treated,  
black enameled head with  
polished faces is designed  
for maximum life



Fiberglass Handle  
Rubber Grip

ITEM #	DESCRIPTION	HANDLE LENGHT	MATERIAL/FINISH/HANDLE	WEIGHT	INNER	MASTER	UPC CODE	BARCODE
155614	Super Club Hammer	15"	Fiberglass Handle	3lb	1	4	20861556140	
155615	Super Club Hammer	15"	Fiberglass Handle	4lb	1	4	20861556157	

Rubber mallet Sledge Hammer



Fiberglass Handle  
Rubber Grip

ITEM #	DESCRIPTION	WEIGHT	MATERIAL/FINISH/HANDLE	FEATURES	INNER	MASTER	UPC CODE	BARCODE
155714	rubber mallet Sledge Hammer	2lbs	Fiberglas Handle	Rubber Grip	6	12	20861557147	
155715	rubber mallet Sledge Hammer	3lbs	Fiberglas Handle	Rubber Grip	6	12	20861557154	

Axes w/Fiberglass Handle



ITEM #	DESCRIPTION	WEIGHT	MATERIAL/FINISH/HANDLE	FEATURES	INNER	MASTER	UPC CODE	BARCODE
155513	Axes w/Fiberglass Handle	1.5lbs	Drop Forged Steel Head	Rubber Grip/15" Handle	6	24	20861555136	
155514	Axes w/Fiberglass Handle	2.5lbs	Drop Forged Steel Head	Rubber Grip/27" Handle	1	12	20861555143	
155516	Axes w/Fiberglass Handle	3.5lbs	Drop Forged Steel Head	Rubber Grip/36" Handle	1	6	20861555167	
735042	Axes - Double Bit w/Fiberglass Handle	3.5lbs	Drop Forged Steel Head	Rubber Grip/36" Handle	1	6	621457350427	

Axes w/Wood Handle



ITEM #	DESCRIPTION	WEIGHT	MATERIAL/FINISH/HANDLE	FEATURES	INNER	MASTER	UPC CODE	BARCODE
155522	Axes w/Wood Handle	2.5lbs	Hickory Handle	21" Handle	1	12	20861555228	
155524	Axes w/Wood Handle	3.5lbs	Hickory Handle	32" Handle	1	6	20861555242	

Camping Axe



Tubular All Steel  
with Vinyl Grip

ITEM #	SIZE	INNER	MASTER	UPC CODE	BARCODE
735021	20oz	6	24	621457350212	

Hatchet - Multi-Use



All Steel  
Rubber Grip

ITEM #	SIZE	INNER	MASTER	UPC CODE	BARCODE
735022	24oz	6	24	621457350229	

2pc Wedges- Steel



132600  
132602

for Hammer , Axe &  
Sledge - Small



132604  
132605

2pc Wedges - Wood

for Hammer , Axe &  
Sledge - Medium/Large



132605

2pc Wedges - Wood/Steel

for Hammer , Axe &  
Sledge - Small

ITEM #	SIZE	INNER	MASTER	UPC CODE	BARCODE
132600	Small - Steel	1	400	20861326002	
132602	Large - Steel	1	400	20861326026	
132604	Small - Wood	1	400	20861326040	
132605	Large - Wood	1	400	20861326057	
132606	Small - Wood/Steel	1	400	20861326064	

Twist Wedge (Head Only)

for Hammer , Axe &  
Sledge - Small



Drop forged, heat treated,  
black enameled head

ITEM #	SIZE	INNER	MASTER	UPC CODE	BARCODE
735101	5 lb	1	4	621457351011	

Maul & Axes

**MAUL**  
Varnished Hickory Handle



155510

- Features:
- Drop Forged Head
  - All Fiberglass handles features rubber grips for added comfort

**MAUL**  
Fiberglass Handle  
Rubber Grip



735106  
735108

**POST MAUL**  
Fiberglass Handle  
Rubber Grip



155530

ITEM #	DESCRIPTION	WEIGHT	MATERIAL/FINISH/HANDLE	FEATURES	INNER	MASTER	UPC CODE	BARCODE
155510	Splitting Maul	8lbs	Hickory Handle /Drop Forged Head	36" Handle	1	4	20861555105	
735106	Splitting maul	6lbs	Fiberglass Handle /Drop Forged Head	36" Handle	1	4	621457351066	
735108	Splitting maul	8lbs	Fiberglass Handle /Drop Forged Head	36" Handle	1	4	621457351080	
155530	Post maul	14lbs	Fiberglass Handle /Drop Forged Head	Rubber Grip	1	4	20861555303	

Axe Combo Set

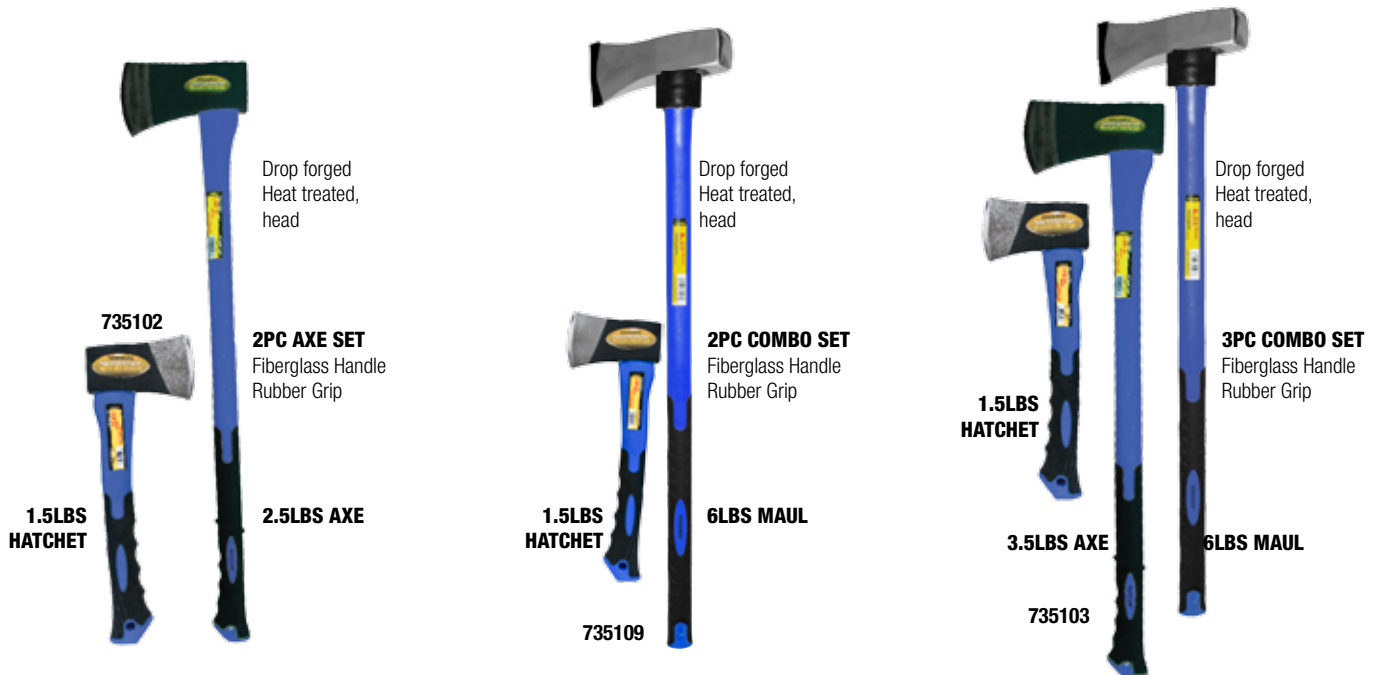

ITEM #	DESCRIPTION	WEIGHT	MATERIAL/FINISH/HANDLE	FEATURES	INNER	MASTER	UPC CODE	BARCODE
735102	2pc Axe Combo Set	1.5, 2.5lbs	Fiberglass Handle /Drop Forged Head	Rubber Grip	1	6	621457351028	
735109	2pc Axe Combo Set	1.5, 6lbs	Fiberglass Handle /Drop Forged Head	Rubber Grip	1	4	621457351097	
735103	3pc axe combo Set	1.5, 3.5, 6lbs	Fiberglass Handle /Drop Forged Head	Rubber Grip	1	2	621457351035	

Replacement Handles



ITEM #	DESCRIPTION	WEIGHT	MATERIAL/FINISH/HANDLE	FEATURES	INNER	MASTER	UPC CODE	BARCODE
132524	Replacement Handles	14"	Ball Pien Hammer	Hickory Handle	1	60	20861325241	
132526	Replacement Handles	16"	Ball Pien Hammer	Hickory Handle	1	60	20861325265	
155717	Replacement Handles	16"	Claw Hammer	Hickory Handle	1	60	20861557178	
132530	Replacement Handles	12"	Brick Hammer	Hickory Handle	1	60	20861325302	
132503	Replacement Handles	12"	Club Hammer	Hickory Handle	1	60	20861325036	
132520	Replacement Handles	16"	Axe Handle	Hickory Handle	1	60	20861325203	
132522	Replacement Handles	28"	Axe Handle	Hickory Handle	1	24	20861325227	
132523	Replacement Handles	32"	Axe Handle	Hickory Handle	1	24	20861325234	
132512	Replacement Handles	36"	Axe Handle	Hickory Handle	1	24	20861325128	
132519	Replacement Handles	36"	Axe Handle	Hickory Handle	1	24	20861325197	
132502	Replacement Handles	36"	Pick Handle	Hickory handle	1	24	20861325029	
132509	Replacement Handles	36"	Pick Handle	Fiberglass Handle	1	20	20861325098	
735141	Replacement Handles	36"	Mini Clay Pick Handle	Fiberglass Handle	6	12	621457351417	
132527	Replacement Handles	16"	Sledge Handle	Hickory handle	1	60	20861325272	
132531	Replacement Handles	32"	Sledge Handle	Hickory handle	1	24	20861325319	
132501	Replacement Handles	36"	Sledge Handle	Hickory handle	1	24	20861325012	
132510	Replacement Handles	36"	Sledge Handle	Fiberglass Handle	1	20	20861325104	
132516	Replacement Handles	48"	Shovel Handle	Fiberglass Handle	1	24	20861325166	
132517	Replacement Handles	28"	Shovel Handle	Ashwood D-Handle	1	24	20861325173	
132541	Replacement Handles	54"	Broom Handle	Hickory handle	1	48	20861325418	
132513	Replacement Handles	51"	Euro Hoe Handle	Hickory handle	1	24	20861325135	
132535	Replacement Handles	43"	Tamper Handle	Hickory handle	1	60	20861325357	



ITEM #	DESCRIPTION	SIZE	FEATURES	INNER	MASTER	UPC CODE	BARCODE
189990	Gorilla bars	12"	Claw & Chisel End	1	24	20861899902	
189991	Gorilla bars	15"	Claw & Chisel End	6	24	20861899919	
189992	Gorilla bars	18"	Claw & Chisel End	6	24	20861899926	
189993	Gorilla bars	24"	Claw & Chisel End	1	12	20861899933	
189989	Gorilla bars	30"	Claw & Chisel End	1	10	20861899896	
189994	Gorilla bars	36"	Claw & Chisel End	1	6	20861899940	
723067	Stripping bar	42" x 7/8	Claw & Chisel End	1	4	621457230675	
723108	T-Type wrecking bar	36" x 3/4"	Claw & Chisel End	1	10	621457231085	
189984	Scraper/Pry Bar	9"	Mirror Tip	20	80	20861899841	
723084	Aligning Bar	24"	3/4" Tip	1	20	621457230842	
190005	Flat Pry bars	7"	With Nail Puller	6	48	20861900059	
190006	Flat Pry bars	13"	With Nail Puller	6	60	20861900066	
190007	Flat Pry bars	15"	With Nail Puller	6	36	20861900073	
189986	Flat Pry bars	18"	Curved Pry Claw	6	36	20861899865	
189999	Digging Bar	70"	17lbs	1	2	20861899995	
190000	Digging Bar	60"	18lbs Chisel Head	1	4	20861900004	
189971	Digging Bar	60"	18lbs Pinch Wedge Head	1	4	20861899711	



ITEM #	DESCRIPTION	WEIGHT	MATERIAL/FINISH/HANDLE	FEATURES	INNER	MASTER	UPC CODE	BARCODE
723042	Nail Puller	10"		Rubber Grip	10	40	621457230422	
189995	Nail Puller	12"		Chrome Plated	6	48	20861899957	
189998	Nail Bar	18"		Slot in Head	5	20	20861899988	
723041	Nail Puller	12"		Double-End	6	48	621457230415	
189996	Nail Puller	21"		Rubber Grip	6	120	20861899964	

Molding Bar

Claw Bar



ITEM #	SIZE	INNER	MASTER	UPC CODE	BARCODE
189980	8"	6	60	20861899803	
189981	10"	6	60	20861899810	
189982	8"	10	60	20861899827	
189983	10"	1	24	20861899834	

Crow Bar/Nail Puller



190001

Mechanical Pry Bar



154300

ITEM #	SIZE	INNER	MASTER	UPC CODE	BARCODE
190001	12"	6	120	20861900011	
154300	18"	1	3	20861543003	

4pc Pry Bar Sets



6", 12", 18", 24"  
Point Head & Heel Base

ITEM #	SIZE	INNER	MASTER	UPC CODE	BARCODE
723024	4pc	12	12	621457230248	

Pry & Wrecking Bars Sets



Pry bar, Nail Bar, Flat Pry Bar, T-Type Wrecking Bar, Pry Bar (Pro) 8"

ITEM #	SIZE	INNER	MASTER	UPC CODE	BARCODE
723036	5pc	1	4	621457230361	

Wrecking Bar



ITEM #	SIZE	INNER	MASTER	UPC CODE	BARCODE
396650	1/2" x 12"	1	24	773544966506	
396651	5/8" x 18"	6	24	773544966513	
396652	3/4" x 24"	4	12	773544966520	
396653	3/4" x 30"	1	10	773544966537	
396654	3/4" x 36"	1	10	773544966544	

Dual Head Wrecking bar



396655

Nail Puller



396657

ITEM #	SIZE	INNER	MASTER	UPC CODE	BARCODE
396655	3/4"X30"	1	10	773544966551	
396657	11"	1	36	773544966575	

Multi-Bit Screwdriver Set



- 4 Square Bits: R0, 1, 2, 3
- 4 Phillips Bits: #0, 1, 2, 3
- 2 Slotted Bits: 3/16", 1/4"
- 2 Torque Bits: T15, T20
- 1 Awl Point
- 1 Screwdriver
- 1 Holster



ITEM #	SIZE	INNER	MASTER	UPC CODE	BARCODE
710143	14pc	6	48	621457101432	

Stubby Ratchet Screwdriver



- 1, 2
- 1, 2



ITEM #	SIZE	INNER	MASTER	UPC CODE	BARCODE
710206	8pc	10	100	621457102064	

7pc Screwdriver Ratchet w/Bits Set

12pc Counter Display  
INDUSTRIAL QUALITY



ITEM #	SIZE	INNER	MASTER	UPC CODE	BARCODE
107010	7pc	12	48	20861070103	

Multi-Bit Screwdriver Set



- Phillips: #1, #2
  - Square: R1, R2
  - Torx\*: T15, T20
  - Slotted: 1/4"
- With Telescopic Magnetic Pickup Industrial Quality



ITEM #	SIZE	INNER	MASTER	UPC CODE	BARCODE
109008	12pc	12	96	20861090088	

Multi-Bit Ratchet Screwdriver



- 1/4" Drive 6pt Sockets:
- 5, 6, 7, 8, 9, 10mm
- 1/4, 5/16, 11/32, 3/8, 7/16, 1/2"
- Bit Adapter
- Ratchet Screwdriver Handle

- 1, 2, 3
- 3, 4, 5
- R1, R2, R3
- T10, T15, T20, T25, T27, T30



ITEM #	SIZE	INNER	MASTER	UPC CODE	BARCODE
710555	34pc	6	24	621457105553	

Screwdriver Ratcheting 13in1



ITEM #	SIZE	INNER	MASTER	UPC CODE	BARCODE
397099	13 in 1	12	48	773544970992	

Screwdriver Multi Bit - 10in1



ITEM #	SIZE	INNER	MASTER	UPC CODE	BARCODE
330102	10 in 1	6	36	773544301024	
397328	7 in 1	12	72	773544973283	

18pc Screwdriver Set



ITEM #	SIZE	INNER	MASTER	UPC CODE	BARCODE
397185					



11pc Screwdriver Sets



- Dual tone heavy-duty handle allows extra leverage
- Large TPR rubber grip for optimum comfort, grip and torque
- Chromium vanadium shaft and bit with magnetic tip

ITEM #	SIZE	INNER	MASTER	UPC CODE	BARCODE
159005	11pc	6	60	20861590052	



12pc Screwdriver Sets

- Go through Shank
- Hex Bolster • Hex Bolster

Slotted I à Fentes:  
6.5 x 38mm  
3.0 x 75mm  
5.5 x 75mm  
8.0 x 150mm  
10.0 x 200mm

Phillips:  
#2 x 38mm  
#0 x 75mm  
#1 x 75mm  
#2 x 100mm  
#3 x 200mm

Robinson Square I Carré:  
#1 x 100mm  
#2 x 150mm

ITEM #	SET	INNER	MASTER	UPC CODE	BARCODE
710477	12pc	1	6	621457104778	



15pc Screwdriver Sets



- Chrome vanadium steel blades
- PRO-GRIP handles for comfort and extra torque

- ⊖ 3/8" x 10" 1/4" x 4"  
3/16" x 4" 1/4" x 1-1/2"
- ⊕ #1 x 3" #3 x 6"  
#2 x 4" #1, #2 x 1-1/2"
- R1 x 6" R3 x 6" Awl 4"  
R2 x 6" R1, R2 x 1-1/2"



ITEM #	SIZE	INNER	MASTER	UPC CODE	BARCODE
710503	15pc	5	10	621457105034	



6pc Screwdriver Sets

- Screwdriver Set Phillips, Slotted & Square
- Unique Designed Hex Nut Head for additional torque



- Go through Shank • Hex Bolster • Hex Bolster

Slotted  
3/16" x 4"  
5/32" x 3"

Phillips:  
PH1 x 3"  
PH2 x 4"

Square  
S1 x 6"  
S2 x 6"

ITEM #	SET	INNER	MASTER	UPC CODE	BARCODE
710478	6pc	12	24	621457104785	

9pc Screwdriver Sets

MATRIX<sup>Canada</sup>



- 5 Pieces - CRV Screwdrivers: Phillips, Slotted & Square
- 4 Pieces - Precision Screwdrivers: Phillips & Slotted

ITEM #	SIZE	INNER	MASTER	UPC CODE	BARCODE
710479	9pc	12	24	621457104792	

37pc Screwdriver Sets

MATRIX<sup>Canada</sup>



Fully Magnetized CRV Blades

- 8 Pieces - CRV Screwdrivers: Phillips, Slotted & Square
- 8 Pieces - Precision Screwdrivers: Phillips, Slotted & Square
- 20 Pieces - CRV Bits: Torx, Phillips, Slotted & Square
- 1 Pieces - Rack

ITEM #	SIZE	INNER	MASTER	UPC CODE	BARCODE
710480	37pc	12	24	621457104808	

52pc Screwdriver Sets

MATRIX<sup>Canada</sup>



Hardened & Tempered Chrome Vanadium Steel Blades

- Fully Magnetized CRV Blades
- 3 Pieces - Bit Holder
- 1 Piece - Ratchet Bits Driver
- 30 Pieces - CRV Bits: Slotted, Hex, Phillips, Torx, Square
- 13 Pieces - Screwdrivers: Slotted, Phillips, Square
- 4 Pieces - Precision Screwdriver Size:
- 1 Pieces - Zip Bag

ITEM #	SIZE	INNER	MASTER	UPC CODE	BARCODE
710476	52pc	1	12	621457104761	

30pc Multi-Bit Screwdriver Set

MATRIX<sup>Canada</sup>



Fully Magnetized CRV Bits

- 24 Pieces - 1" CRV Bits: Phillips, Slotted & Square
- 2 Pieces - Magnetic Nut Driver
- 2 Pieces - 2" Bits: Phillips & Square: Phillips & Square
- 1 Pieces - Rapid Change Connector: 3 position switch enables clockwise, Counter clockwise and locked Ratchet position
- 1 Pieces - Drive Guide

Magnetized Chrome Vanadium Steel Bits with Precision Milled Bit Tips

ITEM #	SIZE	INNER	MASTER	UPC CODE	BARCODE
710481	30pc	12	24	621457104815	

**Firm Gri<sub>2</sub>**

Screwdrivers - Phillips



ITEM #	SIZE	INNER	MASTER	UPC CODE	BARCODE
170142	#0 x 4"	12	120	20861701427	
170128	#1 x 6"	12	120	20861701281	
170144	#1 x 10"	12	120	20861701441	
170129	#2 x 6"	12	120	20861701298	
170131	#2 x 8"	12	120	20861701311	
170133	#2 x 10"	12	120	20861701335	
170150	#2 x 12"	12	120	20861701502	
170130	#3 x 6"	12	120	20861701304	
170132	#3 x 8"	12	120	20861701328	

**Firm Gri<sub>2</sub>**

Screwdrivers - Stubby Phillips



Stubby  
397127



ITEM #	SIZE	INNER	MASTER	UPC CODE	BARCODE
397127	#2 x 1-1/2"	1	144	773544971272	
397129	#1 x 3"	4	144	773544971296	
397130	#2 X 4"	4	144	773544971302	

**Firm Gri<sub>2</sub>**

Screwdrivers - Slotted

Stubby - 397101



ITEM #	SIZE	INNER	MASTER	UPC CODE	BARCODE
397101	1/4" x 4"	1	44	773544971012	
170127	3/16" x 3"	12	120	20861701274	
170151	3/16" x 5"	12	120	20861701519	
170126	1/4" x 5"	12	120	20861701267	
170149	5/16 x 6"	12	120	20861701496	

**Firm Gri<sub>2</sub>**

Screwdrivers - Slotted



ITEM #	SIZE	INNER	MASTER	UPC CODE	BARCODE
397108	1/4" x 4"	1	144	773544971081	
397102	1/8" x 3"	4	144	773544971029	
397114	3/8" x 8"	4	72	773544971142	
397115	3/8" x 10"	1	48	773544971159	

**Firm Gri<sub>2</sub>**

Screwdrivers - Robertson



Robertson Square Recess



ITEM #	SIZE	INNER	MASTER	UPC CODE	BARCODE
170134	#0 x 6"	12	120	20861701342	
170135	#1 x 6"	12	120	20861701359	
170140	#2 x 10"	12	120	20861701403	
170136	#2" x 6"	12	120	20861701366	
170138	#2" x 8"	12	120	20861701380	
170137	#3 x 6"	12	120	20861701373	
170139	#3 x 8"	12	120	20861701397	

**Firm Gri<sub>2</sub>**

Screwdrivers - Square Recessed Tips



Stubby  
397146  
397147

ITEM #	SIZE	INNER	MASTER	UPC CODE	BARCODE
397147	#2 1-1/2" Stubby	4	144	773544971470	
397150	#1 4" x 1/4"	4	144	773544971500	
397151	#2 4" x 1/4"	4	144	773544971517	



Phillips Screwdriver



ITEM #	SIZE	INNER	MASTER	UPC CODE	BARCODE
G08405	#1 x 3"	6	60	84389084059	
G08406	#2 x 4"	6	60	84389084066	



Cabinet Screwdriver



ITEM #	SIZE	INNER	MASTER	UPC CODE	BARCODE
G08401	3/16" x 3"	6	60	84389084011	
G08402	3/16" x 6"	6	60	84389084028	



Square Screwdriver



ITEM #	SIZE	INNER	MASTER	UPC CODE	BARCODE
G08414	1 X 6"	6	60	84389084141	
G08415	S2 X 6"	6	60	84389084158	
G08416	S3 X 6"	6	60	84389084165	



Torx Screwdriver



ITEM #	SIZE	INNER	MASTER	UPC CODE	BARCODE
G08407	15 X 4"	6	60	84389084073	
G08408	20 X 4"	6	60	84389084080	



Slotted Screwdriver



ITEM #	SIZE	INNER	MASTER	UPC CODE	BARCODE
G08403	5/16" x 6"	6	60	84389084035	
G08404	1/4" x 4"	6	60	84389084042	

**GREAT DEALS ON SCREWDRIVERS**



Screw Extractor Sets



ITEM #	SIZE	INNER	MASTER	UPC CODE	BARCODE
711223	8pc, Spiral	10	20	621457112230	

Screw Extractor Sets



ITEM #	SIZE	INNER	MASTER	UPC CODE	BARCODE
711225	6pc, Spiral	10	100	621457112254	

Screwdriver Flex N' Drive Extension



ITEM #	SIZE	INNER	MASTER	UPC CODE	BARCODE
397212		6	36	773544972125	

**Workbench** Series

Screw Extractor Sets



ITEM #	SIZE	INNER	MASTER	UPC CODE	BARCODE
711227	5pc	10	20	621457112278	

9 IN 1 Precision Screwdriver Set



The right tools for the job -- These mini screwdrivers are perfect for getting inside a desktop or laptop, eyeglass, watch & electronics repair - fits in your pocket

Sets Include:  
T5, T6, T7, PH0, PH1, PH2  
Slotted: 2.0, 3.0  
Bit Holder

ITEM #	DESCRIPTION	WEIGHT	MATERIAL/FINISH/HANDLE	FEATURES	INNER	MASTER	UPC CODE	BARCODE
710731	Precision Screwdriver	9pc	Steel	<b>Precision Screwdriver</b>	12	60	621457107311	

12pc Precision Screwdrivers Sets



The right tools for the job -- These mini screwdrivers are perfect for getting inside a desktop or laptop, eyeglass, watch & electronics repair - fits in your pocket

Sets Include:  
T5, T6, T7, PH0, PH1, PH2  
Slotted: 2.0, 3.0, 4.0  
Bit Holder  
3" Mini Diagonal Cutter  
3" Mini Long Nose Pliers

ITEM #	DESCRIPTION	WEIGHT	MATERIAL/FINISH/HANDLE	FEATURES	INNER	MASTER	UPC CODE	BARCODE
710732	Precision Tool Set	12pc	Steel	<b>Precision Tool Set</b>	11	96	621457107328	



6pc Precision Screwdrivers Sets

The handy 6pc Set allows you to access tight areas to repair your television, computer or other high tech devices with ease. Features an assortment of electronic tools for precise adjustments on your high tech device to complete the task quick and painlessly.

- Sets Include:
- 3pcs - Philips Screwdriver: PH00, PH0, PH1
  - 3pcs - Slotted Screwdriver: 5/64", 3/32", 1/8"
  - Aluminum Screwdriver Handle with TPR Grip



ITEM #	DESCRIPTION	WEIGHT	MATERIAL/FINISH/HANDLE	FEATURES	INNER	MASTER	UPC CODE	BARCODE
710734	Precision Screwdriver	6pc	Steel	Precision Screwdriver	12	48	621457107342	



6pc Precision Screwdrivers Sets

The handy 6pc Set allows you to access tight areas to repair your television, computer or other high tech devices with ease. Features an assortment of electronic tools for precise adjustments on your high tech device to complete the task quick and painlessly.

- Sets Include:
- 6pcs - Screwdriver: T5, T6, T7, T8, T9, T10
  - Aluminum Screwdriver Handle with TPR Grip



ITEM #	DESCRIPTION	WEIGHT	MATERIAL/FINISH/HANDLE	FEATURES	INNER	MASTER	UPC CODE	BARCODE
710735	Precision Screwdriver	6pc	Steel	Precision Screwdriver	12	48	621457107359	

Nut Driver Sets



**710607 - 3/16", 1/4", 9/32", 5/16", 11/32", 3/8", 7/16"**  
**7 Pieces - Nut Driver - SAE**  
 Soft Rubber Handle for a secure grip and comfort

**710608 - 5 - 11mm**  
**7 Pieces - Nut Driver - Metric**  
 Soft Rubber Handle for a secure grip and comfort

ITEM #	SIZE	INNER	MASTER	UPC CODE	BARCODE
710607	7PC SAE	5	20	621457106079	
710608	7PC METRIC	5	20	621457106086	

Nut Drivers



710609    710610    710611    710612    710613    710614    710615

ITEM #	SIZE	INNER	MASTER	UPC CODE	BARCODE
710609	3/16" x 3-1/4"	12	120	621457106093	
710610	1/4" x 3-1/4"	12	120	621457106109	
710611	5/16" x 3-1/4"	12	120	621457106116	
710612	11/32" x 3-1/4"	12	120	621457106123	
710613	3/8" x 3-1/4"	12	120	621457106130	
710614	7/16" x 3-1/4"	12	120	621457106147	
710615	1/2" x 3-1/4"	12	120	621457106154	

Impact Driver Sets



- 4pc** Phillips Bits/Foret Phillips: - #1, 2, 3, 4
- 5pc** Flat Bits/Foret Plat: - 5mm (3/16"), 6mm (7/32"), 8mm (9/32"), 10mm (11/32"), 12mm (1/2")
- 4pc** Hex Bits/Foret Het: - 4mm, 5mm, 6mm, 8mm

ITEM #	SIZE	INNER	MASTER	UPC CODE	BARCODE
710892	14pc	1	20	621457108929	

Precision Screwdrivers Sets

Contains: 3 Phillips, 6 Slotted, 1 Awl, and Magnetic Pick-up Tool

Includes Slotted Sizes: 1.0, 1.2, 1.4, 1.8, 2.4, 3.0mm  
 Phillips Sizes : #00, #0, #1



710729

Contains 2 Phillips, 4 Slotted  
 Sizes: 1.0, 1.2, 1.8, 2.4, 3.0, 3.5mm



710726

ITEM #	SIZE	INNER	MASTER	UPC CODE	BARCODE
710729	11pc	10	100	621457107298	
710726	6pc	12	120	621457107267	

**THE Workbench™ Series**

Nut Driver



**THE Workbench™ Series**

Bit Socket Adapters



ITEM #	SIZE	INNER	MASTER	UPC CODE	BARCODE
170181	3" x 1/4"	1	400	20861701816	
170182	3" x 5/16"	50	500	20861701823	
170183	3" x 3/8"	60	360	20861701830	
170185	3" x 7/16"	1	400	20861701854	
170186	3" x 1/2"	1	400	20861701861	

ITEM #	SIZE	INNER	MASTER	UPC CODE	BARCODE
170504	1/4" x 2"	50	500	20861705043	
170502	3/8" x 2"	50	500	20861705029	

**THE Workbench™ Series**

Bit Holders

**THE Workbench™ Series**

Multi Function Bit & Screw Holder



- 14pc Set**
- Patented quick-release chuck
  - Used with pneumatic and electric tools
  - Magnetized to prevent dropping bits
  - Can be turned to hold a variety of drills



170493  
Magnetic Bit Holder



170494  
Magnetic Screw Holder

ITEM #	SIZE	INNER	MASTER	UPC CODE	BARCODE
170503	2-7/8"	50	500	20861705036	
170501	3-1/2"	50	500	20861705012	
170500	6"	50	500	20861705005	

ITEM #	SIZE	INNER	MASTER	UPC CODE	BARCODE
170493		10	60	20861704930	
170494		10	60	20861704947	
170495	14pc	10	40	20861704954	

10pc Double Ended Drive Bits

- Industrial Quality
- S2 Modified Steel
- Assorted Types



ITEM #	SIZE	INNER	MASTER	UPC CODE	BARCODE
109900	2-1/2"	10	100	20861099005	

10pc Double Ended Drive Bits

- Assorted Types



ITEM #	SIZE	INNER	MASTER	UPC CODE	BARCODE
710802	2-1/2"	10	100	621457108028	

10PC Power Bits & Holder



ITEM #	SIZE	INNER	MASTER	UPC CODE	BARCODE
397380	2"	0	0	773544973801	

13pc Drive Bits with Magnetic Holder

- ⊖ 4, 5.5, 7mm
- ⊕ 1, 2, 3 Adaptor Magnetic Bit Holder
- T T15, T20
- 1, 2, 3



ITEM #	SIZE	INNER	MASTER	UPC CODE	BARCODE
710803	13pc	50	100	621457108035	

10pc Drive Bits

- SQ #1
- SQ #2
- Heat Treated
- High Carbon Steel



ITEM #	SIZE	INNER	MASTER	UPC CODE	BARCODE
710821	2" #1	25	100	621457108219	
710822	2" #2	25	100	621457108226	

10pc Drive Bits Set

- Phillips #1 10pc Set
- Phillips #2 10pc Set
- Heat Treated
- High Carbon Steel



ITEM #	SIZE	INNER	MASTER	UPC CODE	BARCODE
710824	2" #1	10	100	621457108240	
710825	2" #2	10	100	621457108257	

2pc Drive Bits Set

- Heat Treated
- High Carbon Steel

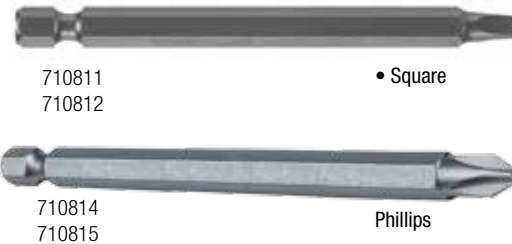

ITEM #	SIZE	INNER	MASTER	UPC CODE	BARCODE
710811	6" #1 - 2pc	25	100	621457108110	
710812	6" #2 - 2pc	50	100	621457108127	
710814	6" #1 - 2pc	25	100	621457108141	
710815	6" #2 - 2pc	25	100	621457108158	

Drive Bits - Phillips



**10 Bits per Pack**  
**Sold by Packs of 10pc**  • Heat Treated  
• S2 Modified Steel

ITEM #	SIZE	INNER	MASTER	UPC CODE	BARCODE
170112	#1 x 1"	10	100	20861701120	
170115	#1 x 2"	10	100	20861701151	
170113	#2 x 1"	10	100	20861701137	
170116	#2 x 2"	10	100	20861701168	
170114	#3 x 1"	10	100	20861701144	
170117	#3 x 2"	10	100	20861701175	
170118	#1 x 3"	10	100	20861701182	
170124	#1 x 6"	10	100	20861701243	
170119	#2 x 3"	10	100	20861701199	
170123	#2 x 6"	10	100	20861701236	
170120	#3 x 3"	10	100	20861701205	
170147	#3 x 6"	10	100	20861701472	

Drive Bits - Square Recess



**10 Bits per Pack**  
**Sold by Packs of 10pc**  • Heat Treated  
• S2 Modified Steel

ITEM #	SIZE	INNER	MASTER	UPC CODE	BARCODE
170121	#1 x 1"	10	100	20861701212	
170102	#1 x 2"	10	100	20861701021	
170105	#1 x 3"	10	100	20861701052	
170160	#1 x 4"	10	100	20861701601	
170125	#1 x 6"	10	100	20861701250	
170100	#2 x 1"	10	100	20861701007	
170103	#2 x 2"	10	100	20861701038	
170106	#2 x 3"	10	100	20861701069	
170161	#2 x 4"	10	100	20861701618	
170122	#2 x 6"	10	100	20861701229	
170101	#3 x 1"	10	100	20861701014	
170104	#3 x 2"	10	100	20861701045	
170107	#3 x 3"	10	100	20861701076	
170162	#3 x 4"	10	100	20861701625	
170148	#3 x 6"	10	100	20861701489	

Drive Bits - Slot



**10 Bits per Pack**  
**Sold by Packs of 10pc**  • Heat Treated  
• S2 Modified Steel

ITEM #	SIZE	INNER	MASTER	UPC CODE	BARCODE
170108	1"	10	100	20861701083	
170109	2"	10	100	20861701090	
170110	3"	10	100	20861701106	

10pc Drive Bits - Mixed

**BONUS**  
1/4" Bit Holder  
Porte-Embout 1/4"

MATRIX  
WITH BELT CLIP / AVEC BRELOQUET

MODIFIED STEEL  
ACIER MODIFIE

20pk / Display

2" |

ITEM #	SIZE	INNER	MASTER	UPC CODE	BARCODE
170200	#1, #2, #3	10	100	20861702004	

Drive Bits - Phillips/Drywall



**10 Bits per Pack**  
**Sold by Packs of 10pc** 

ITEM #	SIZE	INNER	MASTER	UPC CODE	BARCODE
113016	#2 x 1"	10	100	20861130166	

10pc Drive Bits - Square

**BONUS**  
1/4" Bit Holder  
Porte-Embout 1/4"

MATRIX  
WITH BELT CLIP

MODIFIED STEEL

20pk / Display

2" |

ITEM #	SIZE	INNER	MASTER	UPC CODE	BARCODE
170201	Ph, Sq,	20	120	20861702011	

10pc Hex Key Set



SAE: 1/16, 5/64, 3/32,  
1/8, 5/32, 3/16, 7/32,  
1/4, 5/16, 3/8"



ITEM #	SIZE	INNER	MASTER	UPC CODE	BARCODE
702893	SAE	10	60	621457028937	

25pc Hex Key Set



SAE - 1/16~3/8"  
Metric - 1.27~11mm

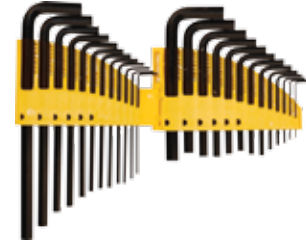

ITEM #	SIZE	INNER	MASTER	UPC CODE	BARCODE
702821	SAE/Metric	10	20	621457028210	

10pc Hex Key Set



Metric: 1.5, 2, 2.5,  
3, 4, 5, 5.5, 6, 8,  
10mm



ITEM #	SIZE	INNER	MASTER	UPC CODE	BARCODE
702894	Metric	10	60	621457028944	

55pc Hex Key Set



SAE: 3/32, 7/64, 1/8, 9/64, 5/32,  
3/16, 7/32, 1/4, 5/16, 3/8"

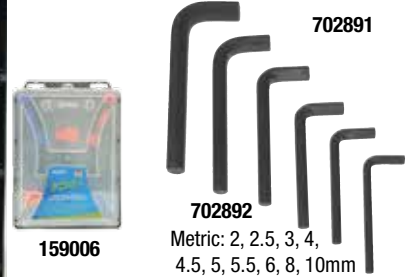

ITEM #	SIZE	INNER	MASTER	UPC CODE	BARCODE
159006	SAE/Metric - 55pc	1	10	20861590069	
702891	SAE - 6pc	1	12	621457028913	
702892	Metric - 6pc	1	12	621457028920	

11pc Drive Torque Socket Set I



1/4":E4, 5, 6, 7, 8  
3/8":E10, 12, 14, 16, 18



10pc T-handle Hex Key Set

SAE: 1/16~3/8"  
Metric: 1.27~11mm



702981  
702982

ITEM #	SIZE	INNER	MASTER	UPC CODE	BARCODE
710841	SAE/1/4", 3/8"	6	36	621457108417	
702981	SAE	1	10	621457029811	
702982	Metric	1	10	621457029828	

15pc Drive Impact Torque Bit Socket Set



710843  
1/4":T10,  
15, 20, 25,  
27, 30  
3/8":T40, 45,  
47, 50



10pc Drive Torque Bit Socket



710846  
T10, 15, 20, 25,  
27, 30, 40, 45, 50

ITEM #	SIZE	INNER	MASTER	UPC CODE	BARCODE
710843	SAE	6	36	621457108431	
710846	Metric	10	30	621457108462	

Canada  
**MATRIX**



9pc Hex Key Set



ITEM #	SIZE	INNER	MASTER	UPC CODE	BARCODE
702895	SAE	10	40	621457028951	
702896	Metric	10	40	621457028968	

Canada  
**MATRIX**

Hex Key 8pc Set  
(Fold-Up) - Sae/Metric



ITEM #	SIZE	INNER	MASTER	UPC CODE	BARCODE
393107	8pc - SAE	6	36	773544931078	
393108	8pc - Metric	6	36	773544931085	

Canada  
**MATRIX**

10pc Ball Point Hex Key Set



ITEM #	SIZE	INNER	MASTER	UPC CODE	BARCODE
393100	10pc - SAE	6	36	773544931009	
393102	10pc - Metric	6	36	773544931023	

Canada  
**MATRIX**

8pc Fold-up Ball Point Hex Key Set



ITEM #	SIZE	INNER	MASTER	UPC CODE	BARCODE
702923	SAE	10	60	621457029231	
702924	Metric	10	60	621457029248	

Canada  
**MATRIX**

9pc Torque Tamper Proof Key Set



ITEM #	SIZE	INNER	MASTER	UPC CODE	BARCODE
710856	SAE/Metric	6	50	621457108561	

Canada  
**MATRIX**

7pc Fold-up Torque Tamper Proof Key Set



ITEM #	SIZE	INNER	MASTER	UPC CODE	BARCODE
393113	7pc	6	36	773544931139	

Hex Key Wrench CR-V 30pc Set

Canada  
**MATRIX**



ITEM #	SIZE	INNER	MASTER	UPC CODE	BARCODE
307330	30pc	1	12	773544073303	

12pc Torque Tamper Proof Bits

Canada  
**MATRIX**



ITEM #	SIZE	INNER	MASTER	UPC CODE	BARCODE
710806	12pc	20	100	621457108066	

33pc Combo Security Bit Set

Canada  
**MATRIX**



ITEM #	SIZE	INNER	MASTER	UPC CODE	BARCODE
710807	33pc	10	60	621457108073	



Canada  
**MATRIX**

**GREAT DEALS ON HEX KEYS**

60pc SAE Socket Wrench Set



<b>3pc</b>	Reversible ratchet handle with built-in speed disc   (1) 1/4" x 5" (2) 3/8" x 8" (3) 1/2" x 10"
<b>1pc</b>	1/2" x 17" Flex Breaker Bar
<b>9pc</b>	1/4" 6-Point Sockets   (1) 3/16" (2) 7/32" (3) 1/4" (4) 9/32" (5) 5/16" (6) 11/32" (7) 3/8" (8) 7/16" (9) 1/2"
<b>7pc</b>	1/4" Deep Wall 6-Point Sockets   (1) 1/4" (2) 9/32" (3) 5/16" (4) 11/32" (5) 3/8" (6) 7/16" (7) 1/2"
<b>9pc</b>	3/8" 6-Point Sockets   (1) 3/8" (2) 7/16" (3) 1/2" (4) 9/16" (5) 5/8" (6) 11/16" (7) 3/4" (8) 13/16" (9) 7/8"
<b>8pc</b>	3/8" Deep Wall 6-Point Sockets   (1) 3/8" (2) 7/16" (3) 1/2" (4) 9/16" (5) 5/8" (6) 11/16" (7) 3/4" (8) 13/16"
<b>13pc</b>	1/2" 6-Point Sockets   7/16, 1/2, 9/16, 5/8, 11/16, 3/4, 13/16, 7/8, 15/16, 1, 1-1/16, 1-1/8, 1-1/4"
<b>3pc</b>	Speed Disc Set
<b>5pc</b>	Extension Bars   (1/4" x 2", 1/4" x 4", 3/8" x 1-3/4", 3/8" x 3", 1/2" x 5")
<b>1pc</b>	1/4" x 6" Spinner Handle
<b>1pc</b>	1/4" Universal Joint

ITEM #	DESCRIPTION	SIZE	MATERIAL/FINISH/HANDLE	FEATURES	INNER	MASTER	UPC CODE	BARCODE
701101	Socket Wrench Set	1/4", 3/8", 1/2"	SAE / 60pc	0	1	2	621457011014	

1/4" 22pc Drive Socket Set



<b>22pc</b>	Socket and Ratchet set   Douille et cliquet ensemble
<b>16pc</b>	Sockets   Douilles - SAE
<b>1pc</b>	6" Ratchet Handle   Poignée de à cliquet
<b>2pc</b>	2" & 4" Extension Bar   Rallonge Poignée
<b>1pc</b>	6" Spinner Handle   Emmanchée Poignée
<b>1pc</b>	Universal Joint   joint universel
<b>1pc</b>	Metal Carrying Case   Étui de transport métal

3/8" 21pc Drive Socket Set



<b>21pc</b>	Socket and Ratchet set   Douille et cliquet ensemble
<b>17pc</b>	Sockets   Douilles - SAE
<b>1pc</b>	8" Ratchet Handle   Poignée de à cliquet
<b>2pc</b>	1-3/4" & 3" Extension Bar   Rallonge Poignée
<b>1pc</b>	Metal Carrying Case   Étui de transport métal

1/2" 17pc Drive Socket Set



<b>17pc</b>	Socket and Ratchet set   Douille et cliquet ensemble
<b>13pc</b>	Sockets   Douilles - SAE
<b>1pc</b>	10" Ratchet Handle   Poignée de à cliquet
<b>2pc</b>	5" Extension Bar   Rallonge Poignée
<b>1pc</b>	15" Flexible Handle
<b>1pc</b>	Metal Carrying Case   Étui de transport métal

ITEM #	DESCRIPTION	SIZE	FEATURES	INNER	MASTER	UPC CODE	BARCODE
701103	22pc Socket Sets	SAE / 1/4"	Deep: 1/4", 9/32", 5/16", 11/32", 3/8", 7/16", 1/2" Shallow: 3/16", 7/32", 1/4", 9/32", 5/16", 11/32", 3/8", 7/16", 1/2"	1	20	621457011038	
701104	22pc Socket Sets	Metric / 1/4"	Deep: 5,5.6,7,8,9,10,11mm Shallow: 4,5,5.5,6,7,8,9,10,11mm	1	20	621457011045	
701105	21pc Socket Sets	SAE / 3/8"	Deep: 3/8", 7/16", 1/2", 9/16", 5/8", 11/16", 3/4, 13/16" Shallow: 3/8", 7/16", 1/2", 9/16", 5/8", 11/16", 3/4, 13/16", 7/8"	1	10	621457011052	
701106	21pc Socket Sets	Metric / 3/8"	Deep: 10,11,12,13,14,15,17,19mm Shallow: 9,10,11,12,13,14, 15,17,19mm	1	10	621457011069	
701107	17pc Socket Sets	SAE / 1/2"	7/16, 1/2, 9/16, 5/8, 11/16, 3/4, 13/16, 7/8, 15/16, 1, 1-1/16, 1-1/8, 1-1/4"	1	6	621457011076	
701108	17pc Socket Sets	Metric / 1/2"	10, 11, 12, 13, 14, 17, 19, 20, 21, 22, 23, 24, 25mm	1	6	621457011083	

40pc Socket Wrench Set



701201



DIY

Drop Forged, Heat Treated | Forgé, traités à la chaleur

40pc	Socket and Ratchet set   Douille et cliquet ensemble - SAE/Metric
1pc	8" (3/8" drive) Reversible Ratchet Handle   Manche à cliquet réversible
1pc	3" Extension Bar   Poignée de à cliquet
1pc	Spinner Handle   Emmanchée Poignée
1pc	Socket Handle   Douille à Poignée
1pc	Spark Plug Socket   Douille Bougie d'allumage
1pc	Spin Disc   Disque de rotation
1pc	Metal Carrying Case   Étui de transport métal
15pc	1/4" Drive Sae Sockets
12pc	1/4" Drive Metric Sockets
3pc	3/8" Drive SAE Sockets
3pc	3/8" Drive Metric Sockets

ITEM #	SIZE	INNER	MASTER	UPC CODE	BARCODE
701201	1/4", 3/8"	1	10	621457012011	

52pc Socket Wrench Set



701204

Drop Forged, Heat Treated | Forgé, traités à la chaleur

52pc	Socket and Ratchet set   Douille et cliquet ensemble - SAE/Metric
1pc	8"/10" (3/8"/1/2" drive) Reversible Ratchet Handle   Manche à cliquet réversible
1pc	3" Extension Bar   Poignée de à cliquet
1pc	Spinner Handle   Emmanchée Poignée
1pc	Socket Handle   Douille à Poignée
1pc	Spark Plug Socket   Douille Bougie d'allumage
1pc	Spin Disc   Disque de rotation
1pc	Metal Carrying Case   Étui de transport métal
15pc	1/4" Drive SAE Sockets   Douilles SAE prise
12pc	1/4" Drive Metric Sockets   Douilles métriques prise
3pc	3/8" Drive SAE Sockets   Douilles SAE prise
3pc	3/8" Drive Metric Sockets   Douilles métriques prise
10pc	1/2" drive SAE sockets   Douilles SAE prise

ITEM #	SIZE	INNER	MASTER	UPC CODE	BARCODE
701204	1/4", 3/8", 1/2"	1	5	621457012042	

21pc Socket Sets w/Ratchet handle



701151  
701152



21pc	Jumbo Socket and Ratchet set   Douille Jumbo et cliquet ensemble - SAE
	7/8, 15/16, 1, 1-1/16, 1-1/8, 1-3/16, 1-1/4, 1-5/16, 1-3/8, 1-7/16, 1-1/2, 1-5/8, 1-3/4, 1-13/16, 1-7/8, 2"
1pc	20" (3/4" Drive) Reversible Ratchet Handle   Manche à cliquet réversible
1pc	20" Flexible Breaker Bar   Poignée de à cliquet
2pc	4"/8" Extension Bar   Poignée de à cliquet
1pc	Molded Plastic Carrying case   Etui de transport en plastique moulé
16pc	3/4" Drive Sockets   Douille

ITEM #	SIZE	INNER	MASTER	UPC CODE	BARCODE
701151	SAE/3/4"	1	2	621457011519	
701152	Metric/19mm	1	2	621457011526	

9pc Socket Sets - SAE



9pc	Socket SAE Set   Douille Ensemble SAE - 701150
	2-1/16", 2-1/8", 2-3/16", 2-1/4", 2-5/16", 2-3/8", 2-7/16", 2-1/2"

ITEM #	SIZE	INNER	MASTER	UPC CODE	BARCODE
701150	SAE/3/4"	1	2	621457011502	



9pc Socket Sets



- 701549** 5/15, 3/8, 7/16, 1/2, 9/16, 5/8, 11/16, 3/4"
- 701559** 10, 11, 12, 13, 14, 15, 17, 19mm



ITEM #	SIZE	INNER	MASTER	UPC CODE	BARCODE
701549	SAE	1	20	621457015494	
701559	Metric	1	20	621457015593	



14pc Drive Socket Sets



- 701361** 1/4, 5/16, 3/8, 7/16, 1/2, 9/16, 5/8, 11/16, 3/4, 13/16, 7/8, 15/16, 1"
- 701371** 7, 8, 9, 10, 11, 12, 13, 14, 15, 16, 17, 18, 19 mm
- 701381** 3/8, 7/16, 1/2, 9/16, 5/8, 11/16, 3/4, 13/16, 7/8, 15/16, 1"
- 701391** 10, 11, 12, 13, 14, 15, 17, 18, 19, 20, 21, 22, 24mm

ITEM #	SIZE	INNER	MASTER	UPC CODE	BARCODE
701361	SAE 3/8" Dr	1	20	621457013612	
701371	Metric 3/8" Dr	1	20	621457013711	
701381	SAE 1/2" Dr	1	20	621457013810	
701391	Metric 1/2" Dr	1	20	621457013919	



Deep Sockets



- Chrome
- Drop forged
- Heat treated



ITEM #	SIZE	INNER	MASTER	UPC CODE	BARCODE
701121	7/8"	2	60	621457011212	
701122	15/16"	2	60	621457011229	
701123	1"	2	60	621457011236	
701124	1-1/16"	2	60	621457011243	
701125	1-1/8"	2	60	621457011250	
701126	1-3/16"	2	60	621457011267	
701127	1-1/4"	2	60	621457011274	
701128	1-5/16"	2	60	621457011281	
701129	1-3/8"	2	60	621457011298	
701131	1-7/16"	2	30	621457011311	
701132	1-1/2"	2	30	621457011328	
701133	1-5/8"	2	30	621457011335	
701134	1-3/4"	2	30	621457011342	
701135	1-13/16"	2	24	621457011359	
701136	1-7/8"	2	30	621457011366	
701137	2"	2	30	621457011373	



Socket & Wrench Set



159003

- Plastics Holder
- 1/4" x 25L Adapter
- 6" Stubby Adjustable Wrench
- Stubby Ratchet Screwdriver
- 1/4" Drive Extension Bar 2"
- 1/4" Ratchet Handle - Stubby
- 1/4" Sockets 10pc
- 1/4" x 25mm Bit
- Pozzi 3pc
- Torx 7pc
- Robi 4pc
- Slotted 3pc



159004

- Plastics Holder
- 3/8"(F) x 1/4" (M) Adapter
- 6" Stubby Adjustable Wrench
- Stubby Ratchet Screwdriver
- 3/8" Drive Extension Bar
- 3/8" Locking Ratchet
- 1/4" Sockets 20pc
- 3/8" Sockets 7pc
- Assorted Bits 11pc

ITEM #	SIZE	INNER	MASTER	UPC CODE	BARCODE
159003	48pc	5	10	20861590038	
159004	45pc	1	10	20861590045	

1/2" Socket (Shallow Impact) - SAE

ITEM #	SIZE	INNER	MASTER	UPC CODE	BARCODE
701621	3/8"	10	50	621457016217	
701622	7/16"	10	50	621457016224	
701623	1/2"	10	50	621457016231	
701624	9/16"	10	50	621457016248	
701625	5/8"	10	50	621457016255	
701626	11/16"	10	50	621457016262	
701627	3/4"	10	50	621457016279	
701628	13/16"	10	50	621457016286	
701629	7/8"	10	50	621457016293	
701631	15/16"	10	50	621457016316	
701632	1"	10	50	621457016323	
701633	1-1/16"	10	50	621457016330	
701634	1-1/8"	10	50	621457016347	
701635	1-1/4"	10	50	621457016354	



ITEM #	SIZE	INNER	MASTER	UPC CODE	BARCODE
701501	3/8"	10	50	621457015012	
701502	7/16"	10	50	621457015029	
701503	1/2"	10	50	621457015036	
701504	9/16"	10	50	621457015043	
701505	5/8"	10	50	621457015050	
701506	11/16"	10	50	621457015067	
701507	3/4"	10	50	621457015074	
701508	13/16"	10	50	621457015081	
701509	7/8"	10	50	621457015098	
701511	15/16"	10	50	621457015111	
701512	1"	10	50	621457015128	
701513	1-1/16"	10	50	621457015135	
701514	1-1/8"	10	50	621457015142	
701515	1-1/4"	10	50	621457015159	

1/2" Socket - Drive (Deep Impact) - SAE



ITEM #	SIZE	INNER	MASTER	UPC CODE	BARCODE
701480	10mm	10	50	621457014800	
701481	11mm	10	50	621457014817	
701482	12mm	10	50	621457014824	
701483	13mm	10	50	621457014831	
701484	14mm	10	50	621457014848	
701485	15mm	10	50	621457014855	
701486	16mm	10	50	621457014862	
701487	17mm	10	50	621457014879	
701488	18mm	10	50	621457014886	
701489	19mm	10	50	621457014893	
701491	21mm	10	50	621457014916	
701492	22mm	10	50	621457014923	
701494	24mm	10	50	621457014947	
701497	27mm	10	50	621457014978	
701599	29mm	10	60	621457015999	
701600	30mm	10	30	621457016002	
701602	32mm	10	30	621457016026	
701603	33mm	10	30	621457016033	
701604	34mm	10	30	621457016040	
701605	35mm	10	30	621457016057	
701606	36mm	10	30	621457016064	
701608	38mm	10	30	621457016088	

1/2" Drive Deep Impact - Metric

**FREE Display Unit**  
with the purchase of  
**Matrix Impact Sockets**  
Conditions apply, call for details

**Présentoir GRATUIT avec**  
l'achat de  
**douilles à choc Matrix**  
Des conditions s'appliquent,  
veuillez appeler pour plus  
de détails





15pc Impact Socket Set



701585  
701595

Drive Size: 1/2 in. | Measurement: SAE/Metric  
Material: Chrome Vanadium  
Socket Depth: Deep | Socket Points: 6

<b>15pc</b>	Socket SAE Set - Deep   Douille Ensemble SAE - Profond
	3/8, 7/16, 1/2, 9/16, 5/8, 11/16, 3/4, 13/16, 7/8, 15/16, 1, 1-1/16, 1-1/8, 1-1/4"
<b>15pc</b>	Socket Metric Set - Deep   Douille Ensemble Métrique - Profond
	10, 12, 13, 15, 16, 17, 18, 19, 21, 22, 24, 27, 30, 32mm



ITEM #	SIZE	INNER	MASTER	UPC CODE	BARCODE
701585	SAE/Deep	1	5	621457015852	
701595	Metric/Shallow	1	5	621457015951	



15pc Impact Socket Sets



701565  
701575

Drive Size: 1/2 in. | Measurement: SAE/Metric  
Material: Chrome Vanadium  
Socket Depth: Shallow | Socket Points: 6

<b>15pc</b>	Socket SAE Set - Shallow   Douille Ensemble SAE - Peu Profond
	3/8, 7/16, 1/2, 9/16, 5/8, 11/16, 3/4, 13/16, 7/8, 15/16, 1, 1-1/16, 1-1/8, 1-1/4"
<b>15pc</b>	Socket Metric Set - Shallow   Douille Ensemble Métrique - Peu Profond
	10, 12, 13, 15, 16, 17, 18, 19, 21, 22, 24, 27, 30, 32mm



ITEM #	SIZE	INNER	MASTER	UPC CODE	BARCODE
701565	SAE	1	10	621457015654	
701575	Metric	1	10	621457015753	



11pc Shallow Impact Socket Sets



<b>701561</b>	1/4, 5/16, 3/8, 7/16, 1/2, 9/16, 5/8, 11/16, 3/4, 13/16, 7/8, 15/16, 1"
<b>701571</b>	7, 8, 9, 10, 11, 12, 13, 14, 15, 16, 17, 18, 19mm

ITEM #	SIZE	INNER	MASTER	UPC CODE	BARCODE
701561	SAE	1	20	621457015616	
701571	Metric	1	20	621457015715	



11pc Deep Impact Socket Sets



<b>701581</b>	1/2, 9/16, 5/8, 11/16, 3/4, 13/16, 7/8, 15/16, 1"
<b>701591</b>	10, 12, 13, 15, 17, 18, 21, 22, 24mm

ITEM #	SIZE	INNER	MASTER	UPC CODE	BARCODE
701581	SAE	1	10	621457015814	
701591	Metric	1	10	621457015913	



9pc Deep Impact Socket Sets



<b>701429</b>	3/16, 7/32, 1/4, 9/32, 5/16, 11/32, 3/8, 7/16"
<b>701449</b>	3/8, 7/16, 1/2", 9/16, 5/8, 11/16, 3/4", 13/16"
<b>701469</b>	1/2, 9/16, 5/8, 11/16, 3/4, 13/16, 7/8, 15/16"

ITEM #	SIZE	INNER	MASTER	UPC CODE	BARCODE
701429	SAE	5	40	621457014299	
701449	SAE	1	20	621457014497	
701469	SAE	1	10	621457014695	



9pc Deer Impact Socket Sets



<b>701439</b>	5, 6, 7, 8, 9, 10, 11, 12mm
<b>701459</b>	10, 11, 12, 13, 14, 15, 17, 18mm
<b>701479</b>	13, 14, 15, 17, 18, 19, 21, 22mm

ITEM #	SIZE	INNER	MASTER	UPC CODE	BARCODE
701439	Metric	5	40	621457014398	
701459	Metric	1	20	621457014596	
701479	Metric	1	10	621457014794	

2pc Impact Adapter Set



2pc 1/4" (F) x 3/8" (M), 3/8" (F) x 1/2" (M),

ITEM #	SIZE	INNER	MASTER	UPC CODE	BARCODE
701611	2pc Adapter	50	100	621457016118	

3pc Impact Adapter Set



3pc 1/4" (F) x 3/8" (M), 3/8" (F) x 1/2" (M), 1/2" (F) x 3/4" (M)

ITEM #	SIZE	INNER	MASTER	UPC CODE	BARCODE
701613	3pc Adapter	50	100	621457016132	

2pc Impact Reducer Set



2pc 3/8" (F) x 1/4" (M), 1/2" (F) x 3/8" (M),

ITEM #	SIZE	INNER	MASTER	UPC CODE	BARCODE
701612	2pc Adapter	60	120	621457016125	

3pc Impact Reducer Set



3pc 3/8" (F) x 1/4" (M), 1/2" (F) x 3/8" (M), 3/4" (F) x 1/2" (M)

ITEM #	SIZE	INNER	MASTER	UPC CODE	BARCODE
701614	3pc Adapter	50	100	621457016149	

3pc Impact Universal Joint Set



701615



3pc 1/4, 3/8, 1/2"

ITEM #	SIZE	INNER	MASTER	UPC CODE	BARCODE
701615	3pc Adapter	24	48	621457016156	

Socket Holder Set



701683

701684  
701685  
701686

ITEM #	SIZE	INNER	MASTER	UPC CODE	BARCODE
701683	1/4", 3/8", 1/2"	25	50	621457016835	
701684	1/4" - 14 Socket	50	100	621457016842	
701685	3/8" - 12 Socket	50	100	621457016859	
701686	1/2" - 12 Socket	50	100	621457016866	



Extension Bar Drive Sets



ITEM #	DESCRIPTION	DRIVE	MATERIAL/FINISH/HANDLE	FEATURES	INNER	MASTER	UPC CODE	BARCODE
701616	Impact Extension Bar 3PC Set	3/8"	Chrome Vanadium Steel	3pc Set - 3, 6, 8"	20	46	621457016163	
701618	Impact Extension Bar 3PC Set	1/2"	Chrome Vanadium Steel	3pc Set - 3, 6, 8"	15	30	621457016187	
701660	4PC Short Extension Bar Set	1/4"	Chrome Vanadium Steel	4pc Set - 3, 6, 9, 12"	10	40	621457016606	
701661	4PC Short Extension Bar Set	3/8"	Chrome Vanadium Steel	4pc Set - 3, 6, 9, 12"	10	30	621457016613	
701671	4PC Short Extension Bar Set	1/2"	Chrome Vanadium Steel	4pc Set - 3, 6, 9, 12"	10	20	621457016712	
701682	2PC Short Extension Bar Set	3/4"	Chrome Vanadium Steel	2pc Set - 4, 8"	5	15	621457016828	
701662	3PC Long Extension Bar Set	3/8"	Chrome Vanadium Steel	3pc Set - 18, 24, 30"	1	12	621457016620	
701672	3PC Long Extension Bar Set	1/2"	Chrome Vanadium Steel	3pc Set - 18, 24, 30"	1	6	621457016729	



Flex & Sliding Bars



ITEM #	DESCRIPTION	SIZE	MATERIAL/FINISH/HANDLE	FEATURES	INNER	MASTER	UPC CODE	BARCODE
701911	Flex Bar	3/8" x 12"	Chrome Vanadium Steel	0	5	50	621457019119	
701913	Flex Bar	1/2" x 17"	Chrome Vanadium Steel	0	5	20	621457019133	
701917	Flex Bar	1/2" x 24"	Chrome Vanadium Steel	0	5	20	621457019171	
701919	Flex Bar	3/4" x 18"	Chrome Vanadium Steel	0	5	10	621457019195	
701918	Flex Bar Head	1/2"	Chrome Vanadium Steel	0	5	20	0	
701920	Sliding T-Bar	3/4" x 18"	Chrome Vanadium Steel	0	10	20	621457019201	

Ratchet Handle - Stubby



- 191016
- Chrome vanadium steel
  - 72 teeth ratchet system
  - 3/8" and 1/4" drive Ratchet handle
  - Includes counter-top display
  - 12pc Display

- 191017
- Chrome vanadium steel
  - 72 teeth ratchet system
  - 3/8" and 1/2" drive Ratchet handle
  - Includes counter-top display
  - 6pc Display

ITEM #	SIZE	INNER	MASTER	UPC CODE	BARCODE
191016	1/4-3/8"	12	48	20861910164	
191017	3/8-1/2"	6	36	20861910171	

Ratchet - Rubber Grip



- 701842  
701843  
701844

ITEM #	SIZE	INNER	MASTER	UPC CODE	BARCODE
701842	1/4"	12	48	621457018426	
701843	3/8"	12	48	621457018433	
701844	1/2"	12	36	621457018440	

Ratchet - HD



- 701857  
701858  
701859

ITEM #	SIZE	INNER	MASTER	UPC CODE	BARCODE
701857	1/4"	12	72	621457018570	
701858	3/8"	12	48	621457018587	
701859	1/2"	12	36	621457018594	

Ratchet - Quick Release



- 701816  
701817  
701818

ITEM #	SIZE	INNER	MASTER	UPC CODE	BARCODE
701816	1/4"	5	50	621457018167	
701817	3/8"	5	40	621457018174	
701818	1/2"	5	30	621457018181	

Ratchet - Jumbo



701845 - Ratchet



701847 - Quick Release

ITEM #	SIZE	INNER	MASTER	UPC CODE	BARCODE
701845	3/4"	1	10	621457018457	
701847	3/4"	1	10	621457018471	

Micro Torque Wrench Sets



701861

701862

- Alloy steel
- Precision torque mechanism
- Reversible ratchet
- Includes 3" extension bar and drive adapter

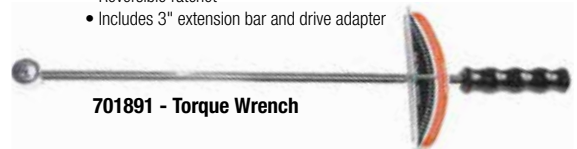

701891 - Torque Wrench

ITEM #	SIZE	INNER	MASTER	UPC CODE	BARCODE
701861	3/8"	1	20	621457018617	
701862	1/2"	1	12	621457018624	
701891	3/8", 1/2"	1	24	621457018914	



Combination Wrench Sets - SAE



14pc 3/8, 7/16, 1/2, 9/16, 5/8, 11/16, 3/4, 13/16, 7/8, 15/16, 1, 1 -1/16, 1-1/8, 1-1/4"

ITEM #	SIZE	INNER MASTER	UPC CODE	BARCODE
702106	3/8 - 1-1/4" SAE	1	5 621457021068	



Combination Wrench Sets - Metric



15pc 10, 11, 12, 13, 14, 15, 16, 17, 18, 19, 20, 21, 22, 23, 24mm

ITEM #	SIZE	INNER MASTER	UPC CODE	BARCODE
702116	10 - 24mm Metric	1	6 621457021167	



11pc Combination Wrench SAE/Metric Set



702101 - SAE  
702111 - Metric



11pc 1/4, 5/16, 3/8, 7/16, 1/2, 9/16, 5/8, 11/16, 3/4, 13/16, 7/8"  
11pc 6, 8, 9, 10, 12, 13, 14, 15, 17, 18mm

ITEM #	SIZE	INNER MASTER	UPC CODE	BARCODE
702101	11pc	1	20 621457021013	
702111	6 - 18mm	1	20 621457021112	



22pc Combination Wrench SAE/Metric Sets



11pc 1/4, 5/16, 3/8, 7/16, 1/2, 9/16, 5/8, 11/16, 3/4, 13/16, 7/8"  
11pc 10, 11, 12, 13, 14, 15, 16, 17, 18, 19mm

ITEM #	SIZE	INNER MASTER	UPC CODE	BARCODE
702121	SAE/Metric	1	10 621457021211	



Jumbo Combo Wrench Sets



- Drop Forged
- Heat Treated
- Heat Tempered

702159 4pc SAE: 2-1/8, 2-1/4, 2-3/8, 2-1/2"  
702156 6pc 1-3/8, 1-1/2, 1-5/8, 1-3/4, 1-7/8, 2"  
702158 10pc 1-5/16, 1-3/8, 1-7/16, 1-1/2, 1-5/8, 1-11/16, 1-3/4, 1-13/16, 1-7/8, 2"

ITEM #	SIZE	INNER MASTER	UPC CODE	BARCODE
702159	4pc - SAE	1	2 621457021594	
702156	6pc - SAE	1	2 621457021563	
702158	10pc - SAE	1	2 621457021587	



5pc Ratcheting Offset Box Wrench Sets- SAE



5pc 1-3/8, 1-1/2, 1-5/8, 1-3/4, 1-7/8"

ITEM #	SIZE	INNER	MASTER	UPC CODE	BARCODE
702435	5pc - SAE	1	12	621457024359	

5pc Ratcheting Offset Box Wrench Sets - Metric



5pc 6x8, 10x12, 11x13, 14x17, 19x21mm

ITEM #	SIZE	INNER	MASTER	UPC CODE	BARCODE
702436	5pc - Metric	1	12	621457024366	

Flare Nut Wrench Sets



702301 3pc SAE: 3/8" x 7/16", 1/2" x 9/16", 5/8" x 11/16"  
 702302 3pc Metric: 11x12mm, 13x14mm, 15x17mm

ITEM #	SIZE	INNER	MASTER	UPC CODE	BARCODE
702301	3pc - SAE	5	50	621457023017	
702302	3pc - Metric	5	50	621457023024	

2pc Rubber Strap Wrench



708568



398660

Two sizes include small size for diameters up to 4" and large size for diameters up to 6".  
 Strap Wrench Set loosens and tightens almost everything!

ITEM #	SIZE	INNER	MASTER	UPC CODE	BARCODE
708568	2pc	12	24	621457085688	
398660	2pc - 4 & 6"	1	24	773544986603	

Combination Wrenches - SAE

ITEM #	SIZE	INNER	MASTER	UPC CODE	BARCODE
702171	1/4"	12	120	621457021716	
702172	5/16"	12	120	621457021723	
702173	3/8"	12	120	621457021730	
702174	7/16"	12	120	621457021747	
702175	1/2"	12	120	621457021754	
702176	9/16"	12	120	621457021761	
702177	5/8"	12	120	621457021778	
702178	11/16"	12	120	621457021785	
702179	3/4"	6	60	621457021792	
702180	13/16"	6	60	621457021808	
702181	7/8"	6	60	621457021815	
702182	15/16"	6	60	621457021822	
702183	1"	6	60	621457021839	
702184	1-1/16"	6	36	621457021846	
702185	1-1/8"	6	36	621457021853	
702186	1-1/4"	6	36	621457021860	



- Long series
- V-Shaped open end
- Drop forged, hardened and tempered steel
- Fully polished
- Chrome plated



Combination Wrenches - Metric

ITEM #	SIZE	INNER	MASTER	UPC CODE	BARCODE
702211	6mm	12	120	621457022119	
702212	7mm	12	120	621457022126	
702213	8mm	12	120	621457022133	
702214	9mm	12	120	621457022140	
702215	10mm	12	120	621457022157	
702216	11mm	12	120	621457022164	
702217	12mm	12	120	621457022171	
702218	13mm	12	120	621457022188	
702219	14mm	12	120	621457022195	
702220	15mm	12	120	621457022201	
702221	16mm	6	120	621457022218	
702222	17mm	6	120	621457022225	
702223	18mm	6	60	621457022232	
702224	19mm	6	60	621457022249	
702225	20mm	6	60	621457022256	
702226	21mm	6	60	621457022263	
702227	22mm	6	60	621457022270	
702228	23mm	6	60	621457022287	
702229	24mm	6	60	621457022294	



- Long series
- V-Shaped open end
- Drop forged, hardened and tempered steel
- Fully polished
- Chrome plated



Stylish Display Stand

Adjustable Wrenches



Drop Forged, Chrome Plated,

ITEM #	SIZE	INNER	MASTER	UPC CODE	BARCODE
702602	6"	6	36	621457026025	
702603	8"	6	60	621457026032	
702604	10"	6	36	621457026049	
702605	12"	6	36	621457026056	
702606	15"	6	12	621457026063	
702607	18"	6	60	621457026070	
702608	24"	2	6	621457026087	

Adjustable Wrench CR-V Pro-Grip



702611, 702612, 702613, 702614, 702615



708572

ITEM #	SIZE	INNER	MASTER	UPC CODE	BARCODE
702611	6"	6	60	621457026117	
702612	8"	6	60	621457026124	
702613	10"	6	48	621457026131	
702614	12"	6	24	621457026148	
702615	15"	5	20	621457026155	
708572	4.5"	12	48	621457085725	

Adjustable Wrench  
4PC Set



4pc 6, 8, 10, 12"

ITEM #	SIZE	INNER	MASTER	UPC CODE	BARCODE
702609	4pc - SAE	5	10	621457026094	

Adjustable Wrench  
Set 3PC Comfort Grip

3pc 4, 6, 8"



ITEM #	SIZE	INNER	MASTER	UPC CODE	BARCODE
702610	3pc - SAE	6	60	621457026100	



Anti-Slip Mat

Anti-Slip/Non-Skid Mats

- Multi-uses: tool boxes, work benches, shelves
- Prevents tools from shifting or sliding
- Reduces scratching and corrosion

ITEM #	SIZE	INNER	MASTER	UPC CODE	BARCODE
701724	12 x 72"	1	20	621457017245	
701725	18 x 72"	1	20	621457017252	

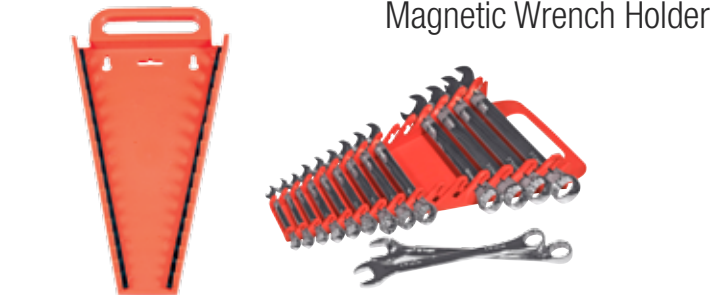

Magnetic Wrench Holder

ITEM #	SIZE	INNER	MASTER	UPC CODE	BARCODE
701702	Holds 12	10	40	621457017023	
701704	Holds 15	10	40	621457017047	

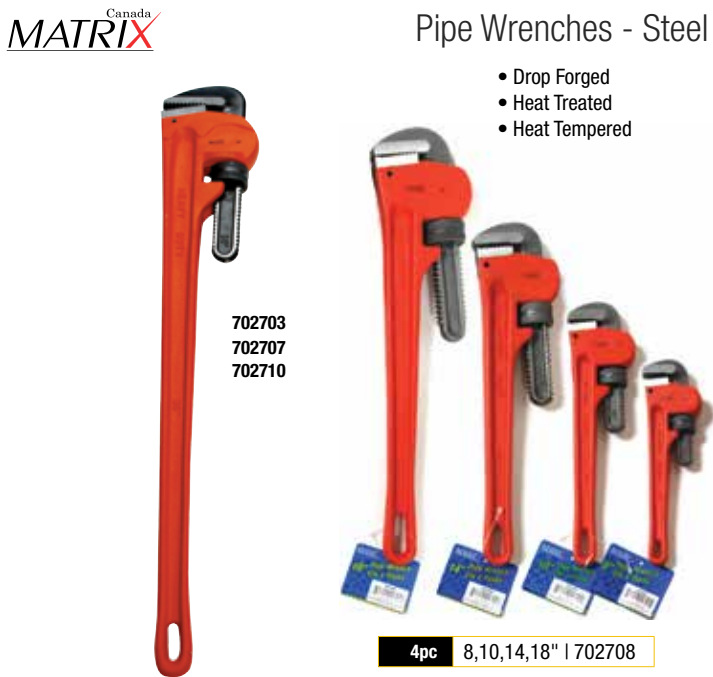

Pipe Wrenches - Steel

- Drop Forged
- Heat Treated
- Heat Tempered

702703  
702707  
702710

4pc 8,10,14,18" | 702708

ITEM #	SIZE	INNER	MASTER	UPC CODE	BARCODE
702703	12"	6	36	621457027039	
702707	36"	2	6	621457027077	
702710	48"	1	2	621457027107	
702708	8,10,14,18"	1	4	621457027084	

MATRIX<sup>Canada</sup> Pipe Wrenches - Aluminum



Drop Forged, Hardened & Tempered Aluminum Alloy

ITEM #	SIZE	INNER	MASTER	UPC CODE	BARCODE
702714	14"	5	20	621457027145	
702715	18"	5	20	621457027152	
702716	24"	5	10	621457027169	
702717	36"	1	4	621457027176	

MATRIX<sup>Canada</sup> Pipe Wrench - Steel



- Drop Forged
- Heat Treated
- Heat Tempered

ITEM #	SIZE	INNER	MASTER	UPC CODE	BARCODE
398702	8"	6	36	773544987020	
398703	10"	6	24	773544987037	
398704	14"	6	12	773544987044	
398705	18"	2	6	773544987051	
398706	24"	1	6	773544987068	

End Cutters Pliers



**CrV**  
 Chrome vanadium steel  
 Nickel-cadium coated  
  
 Acier vanadium chromé  
 Revêtues de cadium  
 nickelé

154080



**HCS**  
 Drop Forged  
 Hardened and Tempered  
 Fully Polished  
  
 Forgées  
 Trempé et revenu  
 entièrement poli

706118

ITEM #	SIZE	INNER	MASTER	UPC CODE	BARCODE
154080	4.5"	6	120	20861540804	
706118	4.5"	6	120	621457061187	

Diagonal Cutters Pliers



**CrV**  
 Chrome vanadium steel  
 Nickel-cadium coated  
  
 Acier vanadium chromé  
 Revêtues de cadium  
 nickelé

154005



**HCS**  
 Drop Forged  
 Hardened and Tempered  
 Fully Polished  
  
 Forgées  
 Trempé et revenu  
 entièrement poli

706117

ITEM #	SIZE	INNER	MASTER	UPC CODE	BARCODE
154005	4.5"	6	120	20861540057	
706117	4.5"	6	120	621457061170	

Long Nose Pliers



**CrV**  
 Chrome vanadium steel  
 Nickel-cadium coated  
  
 Acier vanadium chromé  
 Revêtues de cadium  
 nickelé

154095



**HCS**  
 Drop Forged  
 Hardened and Tempered  
 Fully Polished  
  
 Forgées  
 Trempé et revenu  
 entièrement poli

706115

ITEM #	SIZE	INNER	MASTER	UPC CODE	BARCODE
154095	4.5"	6	120	20861540958	
706115	5"	6	120	621457061156	

Needle Nose Pliers



**CrV**  
 Chrome vanadium steel  
 Nickel-cadium coated  
  
 Acier vanadium chromé  
 Revêtues de cadium  
 nickelé

154070



**HCS**  
 Drop Forged  
 Hardened and Tempered  
 Fully Polished  
  
 Forgées  
 Trempé et revenu  
 entièrement poli

706119

ITEM #	SIZE	INNER	MASTER	UPC CODE	BARCODE
154070	4.5"	12	120	20861540705	
706119	5.5"	6	120	621457061194	

Long Reach Pliers



**CrV**  
 Chrome vanadium steel  
 Nickel-cadium coated  
  
 Acier vanadium chromé  
 Revêtues de cadium  
 nickelé

ITEM #	SIZE	INNER	MASTER	UPC CODE	BARCODE
154090	6.5"	6	60	20861540903	

Bent Nose Pliers



**HCS**  
 Drop Forged  
 Hardened and Tempered  
 Fully Polished  
  
 Forgées  
 Trempé et revenu  
 entièrement poli

ITEM #	SIZE	INNER	MASTER	UPC CODE	BARCODE
706116	5"	6	120	621457061163	



Lineman's Pliers



- Chrome vanadium steel
- Nickle-cadium coated

ITEM #	SIZE	INNER	MASTER	UPC CODE	BARCODE
395676	5"	12	108	773544956767	
395654	7"	1	36	773544956545	
154015	8"	6	48	20861540156	
154016	10"	6	24	20861540163	



Slip Joint Pliers



ITEM #	SIZE	INNER	MASTER	UPC CODE	BARCODE
154124	6"	12	120	20861541245	
154125	8"	6	60	20861541252	
154126	10"	6	48	20861541269	



Cutting Pliers



- Chrome vanadium steel
- Nickle-cadium coated

ITEM #	SIZE	INNER	MASTER	UPC CODE	BARCODE
154006	6"	6	60	20861540064	
153152	7.5"	6	48	20861531529	
154007	8"	6	48	20861540071	



Pliers End Cutting



- Chrome vanadium steel
- Nickle-cadium coated

ITEM #	SIZE	INNER	MASTER	UPC CODE	BARCODE
154081	7"	6	60	20861540811	
154082	8"	6	60	20861540828	



Long Nose Pliers



- Chrome vanadium steel
- Nickle-cadium coated

ITEM #	SIZE	INNER	MASTER	UPC CODE	BARCODE
154096	6"	6	60	20861540965	
154097	8"	6	60	20861540972	



Bent Nose Pliers



- Chrome vanadium steel
- Nickle-cadium coated

ITEM #	SIZE	INNER	MASTER	UPC CODE	BARCODE
154098	6"	6	120	20861540989	
154099	8"	6	60	20861540996	

Pliers HCS



706011  
706013  
706015



706095



706096



706041  
706042



706071  
706072



706085



706081  
706082



706083  
706087



706097  
706099



706091



706093

ITEM #	DESCRIPTION	SIZE	MATERIAL/FINISH/HANDLE	FEATURES	INNER	MASTER	UPC CODE	BARCODE
706011	Pliers Linesman HCS	6"	Dipped grips	Machined jaw	6	60	621457060111	
706013	Pliers Linesman HCS	8"	Dipped grips	Machined jaw	6	60	621457060135	
706015	Pliers Linesman HCS	10"	Dipped grips	Machined jaw	6	48	621457060159	
706095	Pliers Fencing Cutting HCS	10.5"	Dipped grips	Machined jaw	6	36	621457060951	
706096	Pliers Sheet Metal Cutting HCS	8"	Dipped grips	Machined jaw	6	24	621457060968	
706041	Pliers Long Nose HCS	6"	Dipped grips	Machined jaw	6	60	621457060418	
706042	Pliers Long Nose HCS	8"	Dipped grips	Machined jaw	6	60	621457060425	
706071	Pliers Long Nose HCS	6"	Dipped grips	Machined jaw	6	60	621457060715	
706072	Pliers Bent Nose HCS	8"	Dipped grips	Machined jaw	6	60	621457060722	
706085	Pliers Offset Diagonal Cutting HCS	8"	Dipped grips	Machined jaw	6	60	621457060852	
706081	Pliers Diagonal Cutting HCS	6"	Dipped grips	Machined jaw	6	60	621457060814	
706082	Pliers Diagonal Cutting HCS	8"	Dipped grips	Machined jaw	6	60	621457060821	
706083	Pliers Diagonal Cutting HCS	7.5"	Dipped grips	Machined jaw	6	60	621457060838	
706087	Pliers Diagonal Cutting HCS	10"	Dipped grips	Machined jaw	6	48	621457060876	
706097	Pliers End Cutting HCS	8"	Dipped grips	Machined jaw	6	36	621457060975	
706099	Pliers End Cutting HCS	10"	Dipped grips	Machined jaw	6	60	621457060999	
706091	Pliers Crimper Cutting HCS	10"	Dipped grips	Machined jaw	6	48	621457060913	
706093	Pliers Cable Cutting HCS	10"	Dipped grips	Machined jaw	6	36	621457060937	



Long-Reach Pliers HCS



706100  
706141



706101  
706142



706102  
706143



706104  
706144



706105  
706145

- Drop Forged
- Heat Treated
- Heat Tempered
- Fully Polished

ITEM #	DESCRIPTION	SIZE	MATERIAL/FINISH/HANDLE	FEATURES	INNER	MASTER	UPC CODE	BARCODE
706100	Pliers Long Nose Long Reach HCS	11"	Dipped grips	Long Noose	6	60	621457061002	
706141	Pliers Long Nose Long Reach HCS	16"	Dipped grips	Long Noose	6	36	621457061415	
706101	Pliers 25° Bent Nose Long Reach HCS	11"	25 Degree	Bent Noose	6	60	621457061019	
706142	Pliers 25° Bent Nose Long Reach HCS	16"	25 Degree	Bent Noose	6	36	621457061422	
706102	Pliers 45° Bent Nose Long Reach HCS	11"	45 Degree	Bent Noose	6	60	621457061026	
706143	Pliers 45° Bent Nose Long Reach HCS	16"	45 Degree	Bent Noose	6	36	621457061439	
706104	Pliers 90° Bent Nose Long Reach HCS	11"	90 Degree	Bent Noose	6	60	621457061040	
706144	Pliers 90° Bent Nose Long Reach HCS	16"	90 Degree	Bent Noose	6	36	621457061446	
706105	Pliers Circle Nose Long Reach HCS	11"	Long Reach	Circle Noose	6	60	621457061057	
706145	Pliers Circle Nose Long Reach HCS	16"	Long Reach	Circle Noose	6	36	621457061453	

Groove Joint Pliers Cr-V



- Reinforced edge that minimizes stress breakage
- Undercut groove, wont slip.

ITEM #	SIZE	INNER	MASTER	UPC CODE	BARCODE
154515	8"	12	60	20861545151	
154516	10"	6	24	20861545168	
154517	12"	6	12	20861545175	
154518	16"	6	60	20861545182	

Groove Joint Pliers HCS



- Reinforced edge that minimizes stress breakage
- Undercut groove, wont slip.

ITEM #	SIZE	INNER	MASTER	UPC CODE	BARCODE
706222	8"	12	60	621457062221	
706223	10"	6	48	621457062238	
706224	12"	6	30	621457062245	
706227	20"	6	12	621457062276	

Groove Joint Pliers Matte Satin Finish



- Reinforced edge that minimizes stress breakage
- Undercut groove, wont slip.

ITEM #	SIZE	INNER	MASTER	UPC CODE	BARCODE
154519	10" - 12pc	1	12	20861545199	
154520	12" 6pc	6	12	20861545205	

Leverage End-Cutting Pliers



ITEM #	SIZE	INNER	MASTER	UPC CODE	BARCODE
706021	7"			621457060210	

**MULTI FUNCTION**

**HEAVY DUTY PLIERS**

INDUCTION HARDENED CUTTING EDGE  
for superior cutting life

**GREAT DEALS ON PLIERS**

**SHOP NOW & SAVE!**



Leverage Long Nose Pliers



ITEM #	SIZE	INNER MASTER	UPC CODE	BARCODE
706022	8"		621457060227	



Long Nose Pliers - Multi-use



ITEM #	SIZE	INNER MASTER	UPC CODE	BARCODE
G08003	8"	6	24 84389080037	



Leverage Diagonal Cutting Pliers



ITEM #	SIZE	INNER MASTER	UPC CODE	BARCODE
706023	8"		621457060234	



Diagonal Nose Pliers



ITEM #	SIZE	INNER MASTER	UPC CODE	BARCODE
G08004	7"	6	24 84389080044	



Leverage Combination Pliers



ITEM #	SIZE	INNER MASTER	UPC CODE	BARCODE
706020	8"		621457060203	



Linesman Pliers - Multi-use

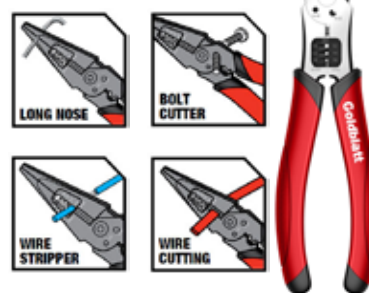

- Sure gripping, cross-hatched knurled jaws
- Strips and cuts 12-18 AWG
- Solid & 14-20 AWG Stranded
- Spring-loaded for Self-opening action
- Ergonomic dual material handle for improved grip and control

ITEM #	SIZE	INNER MASTER	UPC CODE	BARCODE
G08002	8"	6	24 84389080020	

3PC Assorted Pliers Set Locking Mini



- Set includes:**  
 4-1/2" Curved Jaw Locking Pliers  
 4-1/2" "C" Locking Pliers  
 4-1/2" Straight Jaw Locking Pliers

708564

ITEM #	SIZE	INNER	MASTER	UPC CODE	BARCODE
708564	4½"	12	48	621457085640	

4PC Assorted Pliers Set Locking



- Set includes:**  
 5" Curved Jaw Locking Pliers  
 6-1/2" Long Nose Locking Pliers  
 7" Curved Jaw Locking Pliers  
 10" Curved Jaw Locking Pliers

708557

ITEM #	SIZE	INNER	MASTER	UPC CODE	BARCODE
708557	5, 6½, 7, 10"	1	8	621457085572	

3pc C-Clamp Locking Pliers Set



- Set includes:**  
 6" Clamp Capacity: 2", Throat Dept: 1-1/2"  
 9" Clamp Capacity: 3", Throat Dept: 2-1/2"  
 11" Clamp Capacity: 3-3/4", Throat Dept: 2-1/2"

708551

ITEM #	SIZE	INNER	MASTER	UPC CODE	BARCODE
708551	6, 9, 11"	1	6	621457085510	

3pc Assorted Pliers Set



- Set contains**  
 • 10 inch groove joint pliers  
 • 9 inch curved lock grip  
 • 10 inch slip joint pliers  
**Strong, durable tools with rubber handles for better grip**

708556

ITEM #	SIZE	INNER	MASTER	UPC CODE	BARCODE
708556	10, 9, 10"	1	6	621457085565	

3pc Locking Pliers Set



- Chrome vanadium steel
- Ideal for the woodworker, craftsman, or metal worker.
- Cast jaws, steel rail
- Long Noose 6½"
- Curved Jaw 7" & 10"

ITEM #	SIZE	INNER	MASTER	UPC CODE	BARCODE
707103	6½", 7", 10"	5	20	621457071032	

5pc Assorted Pliers Set



- Set Includes**  
 • 5" Locking Pliers  
 • 7" Diagonal Pliers  
 • 8" Slip Joint Pliers  
 • 7" Linesman Pliers  
 • 8" Long Nose Pliers

708582

ITEM #	SIZE	INNER	MASTER	UPC CODE	BARCODE
708582	5, 7, 8, 7, 8"	1	12	621457085824	



4PC Assorted Pliers Set



**Set includes:**  
 6" Slip Joint Plier,  
 6" Diagonal Cutter,  
 6" Linemans Plier,  
 6" Long Nose Cutter



6PC Assorted Pliers Set



**Set includes:**  
 • 6.5-inch diagonal pliers  
 • 8-inch long nose pliers  
 • 8-inch slip joint pliers  
 • 10-inch groove joint pliers  
 • 8-inch linesman pliers  
 • 7-inch diagonal pliers

ITEM #	SIZE	INNER	MASTER	UPC CODE	BARCODE
708403	6"	1	12	621457084032	

ITEM #	SIZE	INNER	MASTER	UPC CODE	BARCODE
708404	6, 8, 8, 10, 8, 7"	1	12	621457084049	



3pc Pliers Mechanics Set



**Set includes:**  
 6" Diagonal Cutter,  
 6" Linemans Plier,  
 6" Long Nose Cutter

706103



4PC Assorted Pliers Set



**Set includes:**  
 Drop forged, Heat treated pliers have a comfort grip padding to protect your hands  
 • 6" Slip joint pliers  
 • 6" Long nose pliers  
 • 6" Diagonal pliers  
 • 6" Linesman pliers

708562

ITEM #	SIZE	INNER	MASTER	UPC CODE	BARCODE
706103	6"	5	20	621457061033	

ITEM #	SIZE	INNER	MASTER	UPC CODE	BARCODE
708562	6"	1	12	621457085626	



5pc Long-Reach Pliers Set



**Set Includes**  
 • 11" Long Nose Pliers  
 • 6" Bent Nose Pliers  
 • 6" Diagonal Pliers  
 • 6" Needle Nose Pliers  
 • 6" End Nipper Pliers

708581



3PC Long-Reach Pliers Set



**Set includes:**  
 11" Long Nose Pliers,  
 11" 90° Bent Nose Pliers  
 11" 45° Bent Nose Pliers

708558

ITEM #	SIZE	INNER	MASTER	UPC CODE	BARCODE
708581	6, 11"	1	12	621457085817	

ITEM #	SIZE	INNER	MASTER	UPC CODE	BARCODE
708558	11"	1	6	621457085589	

Sheet Metal Locking Pliers



707301

- Drop forged
- Hardened and tempered

Welding Locking Pliers



707321

- Drop forged
- Hardened and tempered
- Bulk Packed

ITEM #	SIZE	INNER	MASTER	UPC CODE	BARCODE
707301	10"	6	36	621457073012	

ITEM #	SIZE	INNER	MASTER	UPC CODE	BARCODE
707321	9"	6	36	621457073210	

C-Clamp Locking Pliers

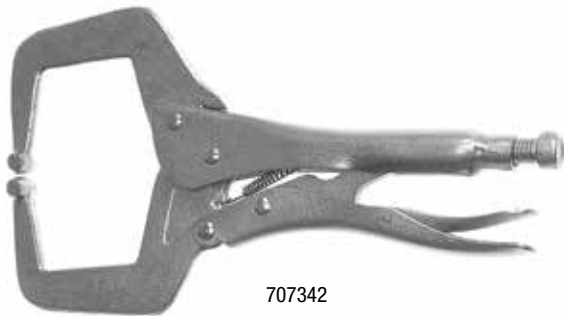

707342

- Drop forged
- Hardened and tempered
- Bulk Packed

C-Clamp Locking Pliers w/Flex Jaws



707351  
707352

- Drop forged
- Hardened and tempered
- Bulk Packed

ITEM #	SIZE	INNER	MASTER	UPC CODE	BARCODE
707342	11"	6	36	621457073425	

ITEM #	SIZE	INNER	MASTER	UPC CODE	BARCODE
707351	6"	6	120	621457073517	
707352	11"	6	36	621457073524	



Curved Jaw Locking Pliers Cr-V



- 153130 Curved Jaw
- 153136 Curved Jaw
- 153132 Curved Jaw
- 153137 Straight Jaw

- Chrome vanadium steel
- Ideal for the woodworker, craftsman, or metal worker.
- Cast jaws, steel rail
- Durable rubber grip for easy holding
- Protective caps prevent marring of work



ITEM #	SIZE	INNER	MASTER	UPC CODE	BARCODE
153130	5" - Curved Jaw	6	60	20861531307	
153136	7" - Curved Jaw	6	48	20861531369	
153132	10" - Curved Jaw	6	24	20861531321	
153137	10" - Straight Jaw	6	24	20861531376	



Curved Jaw Locking Pliers



ITEM #	SIZE	INNER	MASTER	UPC CODE	BARCODE
153142	5"	6	36	20861531420	



Curved Jaw Locking Pliers



- Chrome vanadium steel
- Ideal for the woodworker, craftsman, or metal worker.
- Cast jaws, steel rail
- Curved Jaw 707021: 5"
- Curved Jaw 707022: 7"
- Curved Jaw 707023: 10"

ITEM #	SIZE	INNER	MASTER	UPC CODE	BARCODE
707021	5"	10	60	621457070219	
707022	7"	6	48	621457070226	
707023	10"	6	24	621457070233	



Long Nose Locking Pliers



707122  
707124

Locking Chain Clamp

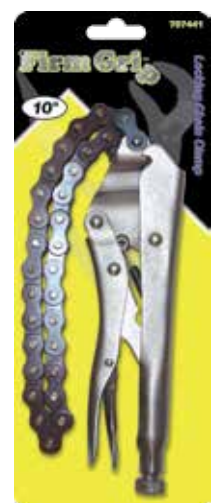

707441

ITEM #	SIZE	INNER	MASTER	UPC CODE	BARCODE
707122	7"	10	60	621457071223	
707124	10"	10	50	621457071247	
707441	10"	12	36	621457074415	

Home Tool 3PC Set



ITEM #	SIZE	INNER	MASTER	UPC CODE	BARCODE
708322	3pc	12	24	621457083226	

Home Decor Tool 4PC Set



ITEM #	SIZE	INNER	MASTER	UPC CODE	BARCODE
708323	4pc	12	24	621457083233	

Home Tool 6PC Set



ITEM #	SIZE	INNER	MASTER	UPC CODE	BARCODE
708325	6pc	12	24	621457083257	

Home Tool 17PC Set



ITEM #	SIZE	INNER	MASTER	UPC CODE	BARCODE
708326	17pc	12	24	621457083264	

Home Tool 18PC Set



ITEM #	SIZE	INNER	MASTER	UPC CODE	BARCODE
708324	18pc	12	24	621457083240	

Home Tool 31PC Set



ITEM #	SIZE	INNER	MASTER	UPC CODE	BARCODE
708327	31pc	12	24	621457083271	

**Firm Gri<sup>®</sup>**

Snap Ring Pliers Set

The single handle unit quickly and easily changes heads.

- Circlip Snap Ring Pliers
- 4pcs Circlip Snap Ring Removing Fittings

45° bent 90° bent, 180° bent tips, Gives you a range from 3/8" to 2".



706301

398500

ITEM #	SIZE	INNER	MASTER	UPC CODE	BARCODE
398500		6	36	74972985009	
706301		6	48	621457063013	

**Firm Gri<sup>®</sup>**

4PC Snap Ring Nose Pliers Set HCS

- For external and internal retainer rings.
- Straight and vertical type.
- Vinyl grip.



ITEM #	SIZE	INNER	MASTER	UPC CODE	BARCODE
706303		6	24	621457063037	

**Firm Gri<sup>®</sup>**

4PC Snap Ring Nose Pliers Set HCS



ITEM #	SIZE	INNER	MASTER	UPC CODE	BARCODE
706304	8"	6	30	621457063044	

**Firm Gri<sup>®</sup>**

4PC Snap Ring Nose Pliers Set HCS



ITEM #	SIZE	INNER	MASTER	UPC CODE	BARCODE
706306	6"	5	30	621457063068	

**Firm Gri<sup>®</sup>**

11PC Snap Ring Pliers Set

Features / Caractéristiques

- 9" bend snap ring pliers with 0.9" tip
- 7.5" straight snap ring pliers with 0.7" tip
- 7.5" bend snap ring pliers with 0.7" tip
- 5.75" straight snap ring pliers with 0.47" tip
- 5.75" bend snap ring pliers with 0.47" tip
- 6" straight snap ring pliers with 0.38" tip
- 6" bend snap ring pliers with 0.38" tip
- 5" hook tool
- 5" pick tool
- Carrying case with handle



ITEM #	SIZE	INNER	MASTER	UPC CODE	BARCODE
706307	11pc	1	12	621457063075	

**Firm Gri<sup>®</sup>**

2PC Snap Ring Nose Pliers Set HCS



ITEM #	SIZE	INNER	MASTER	UPC CODE	BARCODE
706308	10"	1	10	621457063082	

Right Cut Snip



Chrome Molybdenum Alloy Steel  
Acier en Alliage de Chrome Molybdénite



ITEM #	SIZE	INNER	MASTER	UPC CODE	BARCODE
154109	6	36		20861541092	

Straight Cut Snip



Chrome Molybdenum Alloy Steel  
Acier en Alliage de Chrome Molybdénite



ITEM #	SIZE	INNER	MASTER	UPC CODE	BARCODE
154110	6	36		20861541108	

Left Cut Snip



Chrome Molybdenum Alloy Steel  
Acier en Alliage de Chrome Molybdénite



ITEM #	SIZE	INNER	MASTER	UPC CODE	BARCODE
154111	6	36		20861541115	

Right Cut Snip



Chrome Vanadium  
En Chrome Vanadium



ITEM #	SIZE	INNER	MASTER	UPC CODE	BARCODE
154119	6	60		20861541191	

Straight Cut Snip



Chrome Vanadium  
En Chrome Vanadium



ITEM #	SIZE	INNER	MASTER	UPC CODE	BARCODE
154120	5	30		20861541207	

Left Cut Snip



Chrome Vanadium  
En Chrome Vanadium



ITEM #	SIZE	INNER	MASTER	UPC CODE	BARCODE
154121	5	30		20861541214	

**Firm Gri<sup>®</sup>**

Aviation Snip Set



**709022**  
10" Right Cut Snips



**709021**  
10" Straight cut Snips



**709020**  
10" Left Cut Snips



**Firm Gri<sup>®</sup>**

3pc Aviation Tin Snip Set



Drop forged steel blades  
Serrated edged blades induction hardened  
52° to 56°  
Cuts up to 1.22 mm cold rolled steel  
Lever teeth  
Left, right, straight cut

**709023**



ITEM #	SIZE	INNER	MASTER	UPC CODE	BARCODE
709022	10" - Right	10	50	621457090224	
709021	10" - Striaight	5	50	621457090217	
709020	10" - Left	5	50	621457090200	

ITEM #	SIZE	INNER	MASTER	UPC CODE	BARCODE
709023		5	20	621457090231	

Straight Tin Snip

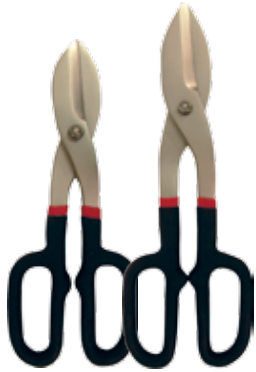

**154112**      **154113**

- Forged, heat treated blades for increased quality and performance
- Grip handle for comfortable use
- Excellent for cutting sheet metal, screening, wire, leather, cloth, gasket material, rubber, linoleum, roofing material, plastics, etc.
- Handles designed for right- or left-hand use



ITEM #	SIZE	INNER	MASTER	UPC CODE	BARCODE
154112	10"	0	36	20861541122	
154113	10"	0	24	20861541139	

Aluminum Tin Snip



- Die cast & light weight, yet strong
- Aluminum handle
- Manganese high carbon alloy steel changeable blade
- Great for cutting aluminum, cable ties, small bushes and more
- 2 replacement blades included



ITEM #	SIZE	INNER	MASTER	UPC CODE	BARCODE
154115		5	20	20861541153	

**Workbench<sup>Series</sup>**

Multi-Function Shears -  
SK5 High Carbon



ITEM #	SIZE	INNER	MASTER	UPC CODE	BARCODE
180005	7" 2/3"	1	12	20861900052	

2PC Comfort Grip Scissors



ITEM #	SIZE	INNER	MASTER	UPC CODE	BARCODE
392515	2pc	6	36	773544925152	

Bolt Cutters



- **Heavy-duty**
- **Chrome Vanadium.**
- **Precision ground jaws that are perfectly aligned for quick action.**
- **Easy to adjust.**

This bolt cutter is perfect for the professional or the do it yourself. Ruggedly built, they are ideal for cutting concrete reinforcing rods, medium tensile and soft bolts, rods, rivets, bars, chains, and cables. The versatile short cutting edge easily accommodates chain links. It features hold firm vinyl grips and a quality steel handle for powerful sure cutting.



Vinyl non-slip grip handle

Precision ground jaws that are perfectly aligned for quick action

Easy to adjust

Steel Handle

154360  
154353

Cuts Metal  
Coupes de Métal

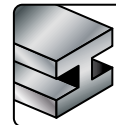

ITEM #	DESCRIPTION	SIZE	MATERIAL/FINISH/HANDLE	FEATURES	INNER	MASTER	UPC CODE	BARCODE
392531	Bolt Cutter	14"	Extra strong bolt cutter	Cr-V	6	24	773544925312	
392532	Bolt Cutter	18"	Extra strong bolt cutter	Cr-V	2	12	773544925329	
392533	Bolt Cutter	24"	Extra strong bolt cutter	Cr-V	1	6	773544925336	
154360	Bolt Cutter Cr-V	30"	Extra strong bolt cutter	Cr-V	1	5	20861543607	
154353	Bolt Cutter Cr-V	36"	Extra strong bolt cutter	Cr-V	1	5	20861543539	

**THE Workbench Series**

Professional Hand Saw

- Professional Handsaw for medium to thick material. (Such as Timber, Plywood, Fiberboard & Chipboard)
- Thick Blade for high precision and straight cutting with exceptionally good stability and comfort.
- Hard pointy teeth for longer lasting sharpness.
- Teflon Coatings - Non-stick performance



**NEW TEFLON COATING**  
NON-STICK PERFORMANCE

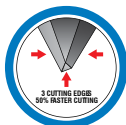

Cuts **50% FASTER** than Traditional Saws

Cuts on Push  
Coupes sur poussoir



Cuts on Pull  
Coupes sur traction



Cuts Timber  
Coupes de bois



Cuts Plywood  
Coupes Contreplaqué



Cuts Chipboard  
Coupes Aggloméré



ITEM #	SIZE	INNER	MASTER	UPC CODE	BARCODE
712028	16"	6	48	621457120280	
712027	22"	6	36	621457120273	
712026	24"	6	36	621457120266	

**THE Workbench Series**

Panel Saw - Drywall



Cuts Chipboard  
Coupes Aggloméré



ITEM #	SIZE	INNER	MASTER	UPC CODE	BARCODE
120033	15"	1	6	20861200333	

**THE Workbench Series**

Drywall Saws



120022



109017

Wallboard Saw  
Rubber Grip



392159

4PC Multi-  
Use Saw



392160

Wallboard Saw  
Wood Handle



392163

Cuts Chipboard  
Coupes Aggloméré



Cuts **50% FASTER** than Traditional Saws

ITEM #	SIZE	INNER	MASTER	UPC CODE	BARCODE
120022	6"	12	48	20861200227	
109017	6"	12	48	20861090170	
392159	6"	6	36	773544921598	
392160	5"	6	36	773544921604	
392163	6"	6	36	773544921635	

Back Saw with PVC Handle (Pro) **THE Workbench Series**

Cuts **50% FASTER** than Traditional Saws  
 Coupures **DE 50% PLUS RAPIDE** que les scies traditionnelles

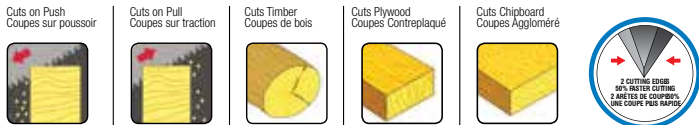

ITEM #	SIZE	INNER	MASTER	UPC CODE	BARCODE
120032	14"	10	40	20861200326	

Mitre Box & Saw Set **THE Workbench Series**

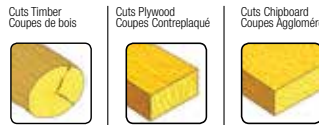

ITEM #	SIZE	INNER	MASTER	UPC CODE	BARCODE
109019	14"	12	48	20861090194	

Undercut Saw HCS Blade w/ Ergonomic Handle **THE Workbench Series**

- For undercutting door jambs and other obstacles during flooring installations
- Extra large, rubberized handle and ergonomic design for additional comfort
- Trapezoid shape for efficiency

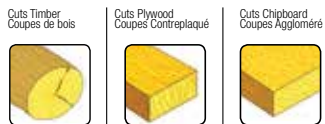

ITEM #	SIZE	INNER	MASTER	UPC CODE	BARCODE
109018	12"	12	72	20861090187	

Door Jamb Saw **Goldblatt** SINCE 1885

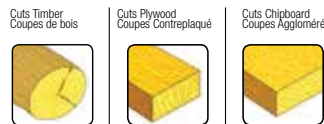
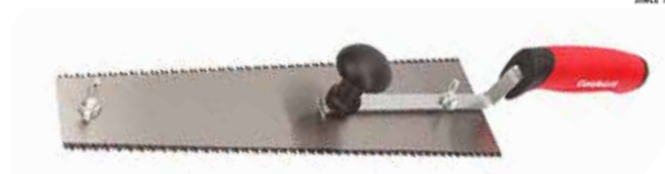

- Used to cut door jambs and other obstacles to allow for flooring to fit underneath
- Premium triple-ground teeth blades
- Offset handle protects knuckles

ITEM #	SIZE	INNER	MASTER	UPC CODE	BARCODE
G02103	45.7 x 10.8 x 7.6 cm	1	6	84389021030	

Mitre Box - Plastic



ITEM #	SIZE	INNER	MASTER	UPC CODE	BARCODE
306500	12"	1	12	773544065001	

Mitre Box & Saw Set - Plastic



ITEM #	SIZE	INNER	MASTER	UPC CODE	BARCODE
306501	12"	1	10	773544065018	

**THE Workbench Series**

2in1 Bow/Hack Saw



- 109020**
- Tubular steel frame
  - Soft Grips
  - Includes 2 blades

Cuts Timber  
Coupes de bois



**THE Workbench Series**

3in1 Bow/Hack Saw



- 181900**
- This versatile functioning saw acts as a bow saw and a hack saw.
  - Easy change blade system includes 2 blades

Cuts Timber  
Coupes de bois



ITEM #	SIZE	INNER	MASTER	UPC CODE	BARCODE
109020	12"	12	24	20861090200	

ITEM #	SIZE	INNER	MASTER	UPC CODE	BARCODE
181900	12"	12	24	20861819009	

**THE Workbench Series**

24" Bow Saw



- 712042**
- Specially designed teeth for excellent cutting, even of green and fibrous wood

Cuts Timber  
Coupes de bois



**THE Workbench Series**

24" Bow Saw



- 109021**
- Strong oval steel frame
  - Vinyl coated handle
  - Specially designed teeth for excellent cutting, even of green and fibrous wood

Cuts Timber  
Coupes de bois



ITEM #	SIZE	INNER	MASTER	UPC CODE	BARCODE
712042	24"	6	24	621457120426	

ITEM #	SIZE	INNER	MASTER	UPC CODE	BARCODE
109021	24"	12	24	20861090217	

**Goldblatt**  
SINCE 1885

Coping Saw w/Carbide Rod Blade



**G02001**

- For cutting curves in Ceramic tile, stone and marble
- Kit includes a 6-in tungsten carbide blade and carbide tipped drill bit
- Diamond coated rod saw blade for long life

Cuts Timber  
Coupes de bois



**G02003**  
Blade Only



ITEM #	SIZE	INNER	MASTER	UPC CODE	BARCODE
G02001	6"	1	6	84389020019	
G02003	6"	6	48	84389020033	

Coping Saw

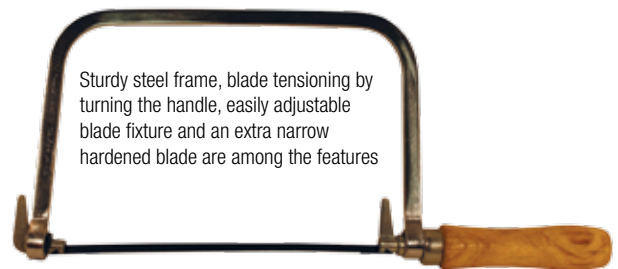

**712022**  
With 5 pack of blades

Sturdy steel frame, blade tensioning by turning the handle, easily adjustable blade fixture and an extra narrow hardened blade are among the features

Cuts Timber  
Coupes de bois



ITEM #	SIZE	INNER	MASTER	UPC CODE	BARCODE
712022	6"	12	48	621457120228	

12' Telescopic Tree Pruner Saw



12' Heavy-duty two section telescoping Aluminum handle



ITEM #	DESCRIPTION	SIZE	MATERIAL/FINISH/HANDLE	FEATURES	INNER	MASTER	UPC CODE	BARCODE
180006	Shear-Pruning-12' Pole	12"	0	0	1	12	20861800069	

7½" Folding Pruning Saw



Blade folds into handle for convenient storage and transport

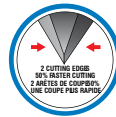

Handy lightweight, folding saw with many uses for trimming branches



ITEM #	DESCRIPTION	SIZE	MATERIAL/FINISH/HANDLE	FEATURES	INNER	MASTER	UPC CODE	BARCODE
712029	Pruning Saw 7 1/2" Folding Design	7½"	0	0	6	48	20861120297	

14" Pruning Saw



ITEM #	DESCRIPTION	SIZE	MATERIAL/FINISH/HANDLE	FEATURES	INNER	MASTER	UPC CODE	BARCODE
120027	Pruning Saw 3 Way Tooth Design	14"	0	0	6	60	20861200272	

THE **Workbench** Series

Rubber Grip Hacksaw



109002

- Ergonomic grip has a soft, warm, high-friction surface with no sharp edges
- Spring-tensioned blade loader assures that blades are centered firmly inside the frame. It is the only part the user needs to use when changing the blade.
- Blades can be installed at 55° angle for flush cutting

Cuts Metal  
Coupes de Métal



ITEM #	SIZE	INNER	MASTER	UPC CODE	BARCODE
109002	10-12"	6	36	20861090026	

THE **Workbench** Series

Tubular Metal Hack Saw



109005

- Adjustable for use with 250mm (10") or 300mm (12") blades
- Tubular steel frame steel handle

Cuts Metal  
Coupes de Métal



ITEM #	SIZE	INNER	MASTER	UPC CODE	BARCODE
109005	10-12"	6	36	20861090057	

THE **Workbench** Series

Steel Frame Hacksaw



120133

- Heat treated, 65Mn steel blade cuts through metal
- Chrome plated all-steel construction
- Wingnut tensions fitting of blades
- 3 notches in frame to adjust and accept 10 & 12" blades

Cuts Metal  
Coupes de Métal



ITEM #	SIZE	INNER	MASTER	UPC CODE	BARCODE
720133	10-12"	6	24	621457201330	

THE **Workbench** Series

Steel Frame Hacksaw w/  
Metal Handle



109007

- Heat treated, 65Mn steel blade cuts through metal
- Chrome plated all-steel construction
- Contoured metal handle for a comfortable grip
- Wingnut tensions fitting of blades
- 3 notches in frame to adjust and accept 8,10 & 12" blades

Cuts Metal  
Coupes de Métal



ITEM #	SIZE	INNER	MASTER	UPC CODE	BARCODE
109007	10-12"	6	36	20861090071	

THE **Workbench** Series

2pc Hacksaw with Mini  
Hacksaw



109013

**BONUS PACK**

- Fully adjustable tension provides longer blade life and fast, accurate cuts
- Blade storage inside frame
- Mini Hacksaw: Comfort foam dipped handle and composite frame for lightweight and easy handling makes it ideal for use in confined spaces
- Accepts 10", 12" and even broken blades

Cuts Metal  
Coupes de Métal



ITEM #	SIZE	INNER	MASTER	UPC CODE	BARCODE
109013	10 & 12"	6	24	20861090132	

THE **Workbench** Series

Aluminum Square Tube  
Hacksaw



109006

- Heavy-duty frame with solid anodized steel frame
- Flat steel back and light alloy handle with adjusting screw
- Alternative 55° sawing angle, facility for flush cutting

Cuts Metal  
Coupes de Métal



ITEM #	SIZE	INNER	MASTER	UPC CODE	BARCODE
109006	12"	6	60	20861090064	

Mini Hi-Tension Hacksaw



- Features a lever molded into the D-Grip handle for quick and easy blade changes
- Deep throat for good work capacity
- Comes with 10" blade



ITEM #	SIZE	INNER	MASTER	UPC CODE	BARCODE
109011	6"	6	48	20861090118	

Aluminum Frame. Hacksaw



- Aluminum die cast Frame
- Easy quick change blade
- Non slip rubber grip handle
- Blade can be positioned for 6 different angle



ITEM #	SIZE	INNER	MASTER	UPC CODE	BARCODE
109003	6"	12	60	20861090033	

Steel Frame Hacksaw



- Steel Frame
- Easy quick change blade
- Rubber grip handle
- Blade can be positioned for 6 different angle



ITEM #	SIZE	INNER	MASTER	UPC CODE	BARCODE
712135	6"	12	120	621457121355	

Mini Hacksaw



ITEM #	SIZE	INNER	MASTER	UPC CODE	BARCODE
392153	10"	6	36	773544921536	



**GREAT DEALS ON HACKSAW**  
**SHOP NOW & SAVE!**

Mini Hacksaw



ITEM #	SIZE	INNER	MASTER	UPC CODE	BARCODE
392169	10"	1	24	773544921697	

**THE Workbench™ Series**

12pc Junior Hacksaw Blades



High carbon steel (HCS) blades are designed for making cuts in soft materials, such as wood, plastics or other synthetic materials. The advantage of HCS saw blades lies in their comparative flexibility especially required for curved or moulded cutting.



ITEM #	SIZE	INNER	MASTER	UPC CODE	BARCODE
712212	6"	20	200	621457122123	

**THE Workbench™ Series**

10pc Hacksaw Blades



High speed steel (HSS) blades are designed for making cuts in soft materials, such as wood, plastics or other synthetic materials. The advantage of HCS saw blades lies in their comparative flexibility especially required for curved or moulded cutting.



ITEM #	SIZE	INNER	MASTER	UPC CODE	BARCODE
119998	12" x 18T	10	180	20861199989	
712201	12" x 24T	10	100	621457122017	

**THE Workbench™ Series**

2pc Hacksaw (HSS) Blades



High-speed steel (HSS) blades are intended for use with harder materials such as ferrous and nonferrous metals including aluminium.



ITEM #	SIZE	INNER	MASTER	UPC CODE	BARCODE
119992	12" x 18T	25	250	20861199927	
119993	12" x 24T	25	250	20861199934	
119994	12" x 32T	25	200	20861199941	

**THE Workbench™ Series**

2pc Hacksaw Bi-Metal Blades



Bi-metal construction for a faster cutting, longer lasting blade that can bend without breaking



ITEM #	SIZE	INNER	MASTER	UPC CODE	BARCODE
119995	12" x 18T	25	200	20861199958	
119996	12" x 24T	25	200	20861199965	

**THE Workbench™ Series**

Jig Saw Blade Set



712245



712248

ITEM #	SIZE	INNER	MASTER	UPC CODE	BARCODE
712245	5pk	20	200	621457122451	
712248	8pk	50	200	621457122482	

**THE Workbench™ Series**

Tungsten Carbide Saw Blade



- Carbide graded hacksaw blade
- For cutting plastic, plexiglass and ceramic



ITEM #	SIZE	INNER	MASTER	UPC CODE	BARCODE
120000	12"	12	240	20861200005	

Folding Utility Knives



190091

- Utility knife with 5 extra blades
- Finger grip handle
- Quick change blade replacement
- Folding lock-back for safety
- Light weight handle with pocket clip

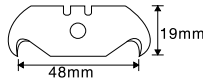
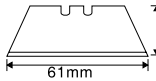

Replacement Blades:  
Lames de Rechange:  
• 190071 • 190073  
• 190070



190092

12pc Stylish Display Box  
Case élégant d'affichage  
12pc



190093

12pc Stylish Display Box  
Case élégant d'affichage  
12pc



190094

12pc Stylish Display Box  
Case élégant d'affichage  
12pc



190095

12pc Stylish Display Box  
Case élégant d'affichage 12pc

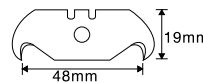
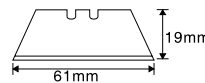

Replacement Blades:  
Lames de Rechange:  
• 190071 • 190073  
• 190070

ITEM #	DESCRIPTION	MATERIAL/FINISH/HANDLE	FEATURES	INNER	MASTER	UPC CODE	BARCODE
190091	Utility Knife Metal Folding With BeL Clip	0	0	12	120	20861900912	
190092	Utility Knife HD Foldable Locking Blue	0	0	12	24	20861900929	
190093	Utility Knife HD Foldable Locking Camouflage	0	0	12	24	20861900936	
190094	Utility Knife HD Foldable Locking Blue With Knife	0	0	12	24	20861900943	
190095	Utility Knife HD Foldable Locking Blue With Drywall Saw	0	0	12	24	20861900950	

**THE Workbench Series** Utility Knife Plastic Push Lock



190012  
• Push lock

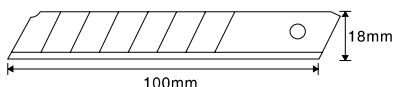

Replacement Blades:  
• 190072  
• 190022  
• 190028

ITEM #	SIZE	INNER	MASTER	UPC CODE	BARCODE
190012	6"	50	400	20861900127	

**THE Workbench Series** Utility Knife Plastic Push Lock



Replacement Blade:  
• 190017

190013  
• Push lock  
• Metal sleeve

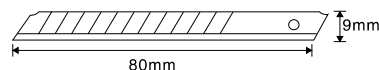

ITEM #	SIZE	INNER	MASTER	UPC CODE	BARCODE
190013	4"	3	240	20861900134	

**THE Workbench Series** Utility Knife Plastic Auto Lock



190052  
• Auto lock  
• 3 blades in the cartridge  
• Auto blade loading  
• Metal sleeve  
• Rubber cushion grip

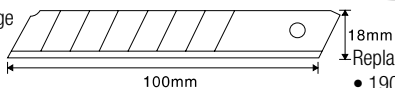

Replacement Blades:  
• 190072 • 190022  
• 190028

ITEM #	SIZE	INNER	MASTER	UPC CODE	BARCODE
190052	6"	12	144	20861900523	

**THE Workbench Series** Utility Knife Plastic Auto Lock



190051  
• Auto lock  
• 5 blades in the cartridge  
• Auto blade loading  
• Rubber cushion grip  
• Metal sleeve

Replacement Blade:  
• 190017

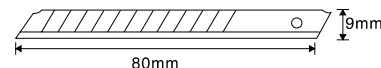

ITEM #	SIZE	INNER	MASTER	UPC CODE	BARCODE
190051	4"	12	288	20861900516	

**THE Workbench Series** Utility Knife Plastic Ratchet Screw Lock



190026  
• Hex-screw lock  
• Snap-off  
• Metal sleeve

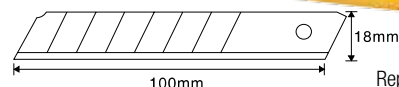

Replacement Blades:  
• 190072 • 190022  
• 190028

ITEM #	SIZE	INNER	MASTER	UPC CODE	BARCODE
190026	6-1/2"	12	120	20861900264	

**THE Workbench Series** Utility Knife Plastic Ratchet Lock



190025  
• Twist lock  
• 25mm blade  
• Rubber cushion grip

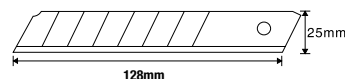

Replacement Blades:  
• 190027 • 190028

ITEM #	SIZE	INNER	MASTER	UPC CODE	BARCODE
190025	8"	12	120	20861900257	

**THE Workbench Series** Auto Feed Snap Off Knife



Comes in a Cut case Display  
Replacement Blades:  
• 190017

ITEM #	SIZE	INNER	MASTER	UPC CODE	BARCODE
395360	9mm	32	128	773544953605	

**THE Workbench Series** Utility Knife Rubber Grip 3PC Set



190038

Replacement Blades:  
• 190022  
• 190028  
• 190072

• 18mm Wide Blade  
• Rubber handle  
• Steel Blade  
• Light Weight Durable Plastic Body  
• All-Purpose precision Cutting

ITEM #	SIZE	INNER	MASTER	UPC CODE	BARCODE
190038	3pc	10	40	20861900387	

Utility Knife Zinc Alloy HD



- 190050** **IND**
- Zinc-alloy body
  - Quick opening



- Replacement Blades:**
- 190071 • 190073
  - 190070

ITEM #	SIZE	INNER	MASTER	UPC CODE	BARCODE
190050		12	120	20861900509	

Utility Knife



- 190031** **IND**
- Zinc-alloy body
  - Quick opening

- Replacement Blades:**
- 190071 • 190073
  - 190070

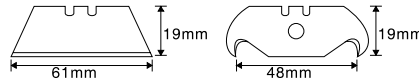

ITEM #	SIZE	INNER	MASTER	UPC CODE	BARCODE
190031		12	48	20861900318	

Utility Knife Zinc Alloy



- 190016**
- Zinc-alloy body
  - Multi-stop button

- Replacement Blades:**
- 190071 • 190073
  - 190070

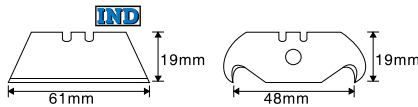

ITEM #	SIZE	INNER	MASTER	UPC CODE	BARCODE
190016		8	96	20861900165	

Utility Knife



- 190030** **IND**
- Zinc-alloy body
  - Rubber grip
  - Auto load
  - 3 blades stored in body
  - Quick opening button

- Replacement Blades:**
- 190071 • 190073
  - 190070

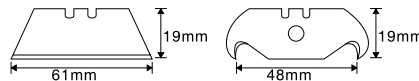

ITEM #	SIZE	INNER	MASTER	UPC CODE	BARCODE
190030		12	60	20861900301	

Utility Knife HD



- 190054** **IND**
- Heavy-duty
  - 3 blades stored in body
  - Quick opening button



- Replacement Blades:**
- 190071 • 190073
  - 190070

ITEM #	SIZE	INNER	MASTER	UPC CODE	BARCODE
190054		16	96	20861900547	

Retractable Knife Zinc Alloy Sk5 Blade



ITEM #	SIZE	INNER	MASTER	UPC CODE	BARCODE
190048		10	60	20861900486	



Folding Retractable Utility Knife



**FOLDING  
RETRACTABLE**

Quick load blade changing system for fast blade changes  
Two replacement blade storage compartments

ITEM #	SIZE	INNER	MASTER	UPC CODE	BARCODE
G08200		1	8	84389082000	



Heavy Duty Retractable Utility Knife



**HEAVY  
DUTY**

Heavy duty zinc alloy construction  
Quick load blade changing system for fast blade changes  
Five replacement blades storage

ITEM #	SIZE	INNER	MASTER	UPC CODE	BARCODE
G08201		1	8	84389082017	



Heavy Duty Fixed Blade Utility Knife



**HEAVY  
DUTY**

Heavy duty zinc alloy construction  
Easy Tool-Free Open with the ability to tighten down with screwdriver  
Five replacement blades storage

ITEM #	SIZE	INNER	MASTER	UPC CODE	BARCODE
G08202		1	8	84389082024	



Utility Scoring Knife



Scores all types of cement based backerboard  
Durable tungsten carbide tips for long life  
Features a folding design for easy storage and transport  
Anodized aluminum handle for durability  
Measures 4-3/8-in closed, 7-1/4-in open

ITEM #	SIZE	INNER	MASTER	UPC CODE	BARCODE
G02736	7.2 x 1.5 x 0.7"	1	8	84389027360	



Pacesetter Scoring Knife



Scores cement based backer board  
Backer board knife with 3 tungsten carbide tips  
Includes chisel tip in handle for shaping  
Contoured soft grip handle for easy handling

ITEM #	SIZE	INNER	MASTER	UPC CODE	BARCODE
G02737		1	8	84389027377	



Pivoting Carpet Knife



- 190055**
- Checkered handle for a slip resistant grip
  - Handle with magnet stores spare blades

**Thumb Blade Guard**  
El pulgar protector de la hoja

ITEM #	SIZE	INNER	MASTER	UPC CODE	BARCODE
190055		10	60	20861900554	

Heavy Duty Utility Knife



- 190049**
- Accepts all utility blades
  - Blade storage in handle

ITEM #	SIZE	INNER	MASTER	UPC CODE	BARCODE
190049		10	60	20861900493	

Multi Purpose Utility Knife (LINO)



- 190037**
- Multi-Purpose Utility Knife
  - Stainless Steel Blade

ITEM #	SIZE	INNER	MASTER	UPC CODE	BARCODE
190037		12	48	20861900370	

Multi Purpose Utility Knife



ITEM #	SIZE	INNER	MASTER	UPC CODE	BARCODE
395370		12	72	773544953704	

Auto-Lock Snap-Off Cutter



ITEM #	SIZE	INNER	MASTER	UPC CODE	BARCODE
395319	18mm	12	72	773544953193	

10PC Replacement Blades



ITEM #	SIZE	INNER	MASTER	UPC CODE	BARCODE
395303	10pc	12	144	773544953032	

Replacement Utility Blades

<p><b>5-Pack</b></p> <p><b>190017</b></p>	<p>80mm 9mm</p>	<p><b>10-Pack</b></p> <p><b>190072</b></p>	<p>100mm 18mm</p>	<p><b>50-Pack</b></p> <p><b>190022</b></p>	<p>100mm 18mm</p>
<p><b>6-Pack</b></p> <p><b>190027</b></p>	<p>128mm 25mm</p>	<p><b>20-Pack</b></p> <p><b>190028</b></p>	<p>128mm 25mm</p>	<p><b>5-Pack</b></p> <p><b>190071</b></p>	<p>61mm 19mm</p>
<p><b>100-Pack</b></p> <p><b>190070</b></p>	<p>61mm 19mm</p>	<p><b>5-Pack</b></p> <p><b>190073</b></p>	<p>48mm 19mm</p>	<p><b>5-Pack</b></p> <p><b>190074</b></p>	<p>58mm 32mm 19mm</p>

ITEM #	DESCRIPTION	SIZE	MATERIAL/FINISH/HANDLE	FEATURES	INNER	MASTER	UPC CODE	BARCODE
190017	Utility Blade With Plastic Box	9 x 80mm	-	12pc per pack	12	180	20861900172	
190072	Utility Blade With Plastic Dispenser	18 x 100mm	-	10pc per pack	18	288	20861900721	
190022	Utility Blade With Plastic Hanging Box	18 x 100mm	-	50pc per pack	12	12	20861900226	
190028	Snap-Off Blades	25 x 128mm	-	20pc per pack	6	60	20861900288	
190071	Utility Blade With Plastic Box	19 x 61mm	-	5pc per pack	24	240	20861900714	
190070	Utility Blade HD With Dispenser	19 x 61mm	-	100pc per pack	8	48	20861900707	
190073	Scraper Blades Roofing Hook	19 x 48mm	-	5pc per pack	12	288	20861900738	
190074	Scraper Blades Razor	19 x 58mm	-	5pc per pack	24	720	20861900745	

Razor Scraper



190060

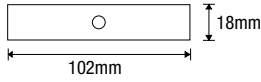

**Replacement Blade:**  
**Lame de Rechange:**  
• 190076



190061

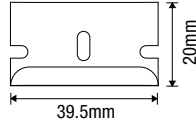

**Replacement Blade:**  
**Lame de Rechange:**  
• 190021 • 190023 •  
190075



190062

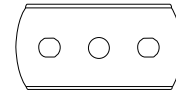

**Replacement Blade:**  
**Lame de Rechange:**  
• 190069



110109

ITEM #	DESCRIPTION	SIZE	MATERIAL/FINISH/HANDLE	FEATURES	INNER	MASTER	UPC CODE	BARCODE
190060	Scraper Retractable W/4" Blade	4"	-		24	240	20861900608	
190061	Scraper Retractable Blade	2"	-		20	240	20861900615	
190062	Scraper Retractable Blade (Pro)	2"	-		20	240	20861900622	
110109	Scraper Double-Edged With Clip Plastic Handle	6pc	-				20861101098	
389507	Mini Plastic Scraper		-		75	300	773544895073	

Razor Scraper Heavy Duty



110110  
**IND**

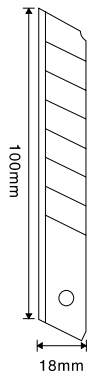

**Replacement Blade:**  
**Lame de Rechange:**  
190072 - 190022



110111  
**IND**

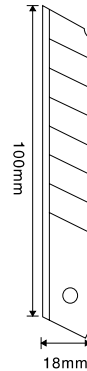

**Replacement Blade:**  
**Lame de Rechange:** 190072  
- 190022



110112  
**IND**

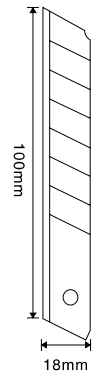

**Replacement Blade:**  
**Lame de Rechange:**  
190072 - 190022

Power Scraping

- Die cast aluminum head, reinforced shaft and steel end cap

Precision Scraping

- Reversible blade for standard or ultra-sharp scraping



Included with / Inclus avec  
110110, 110111, 110112:  
10pc 4" Replacement Blades  
10pc 4" Lames de Remplacement

ITEM #	DESCRIPTION	SIZE	MATERIAL/FINISH/HANDLE	FEATURES	INNER	MASTER	UPC CODE	BARCODE
110110	Scraper Hand Tool HD - Metal Handle	4"	0	0	6	24	20861101104	
110111	Scraper Hand Tool HD - Metal Handle	4"	0	0	6	24	20861101111	
110112	Scraper Hand Tool HD - Metal Handle	4"	0	0	6	24	20861101128	

Replacement Scraper Blades



10-Pack 190021

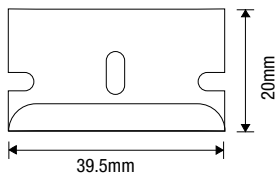

• 190021 • 190023 • 190075



50-Pack 190075

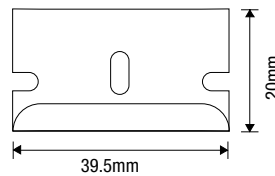

• 190021 • 190023 • 190075



100-Pack 190023

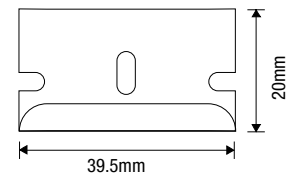

• 190021 • 190023 • 190075

ITEM #	DESCRIPTION	SIZE	MATERIAL/FINISH/HANDLE	FEATURES	INNER	MASTER	UPC CODE	BARCODE
190021	Scraper Blades Razor	39.5mm X 20mm	0	10pc per pack	10	400	20861900219	
190075	Scraper Blades Razor With Dispense	39.5mm X 20mm	0	50pc per pack	10	60	20861900752	
190023	Scraper Blades Razor	39.5mm X 20mm	0	100pc per pack	4	84	20861900233	



10-Pack 190076

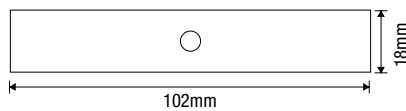

10-Pack 190069

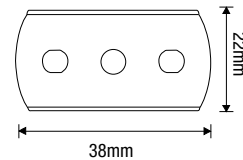

ITEM #	DESCRIPTION	SIZE	MATERIAL/FINISH/HANDLE	FEATURES	INNER	MASTER	UPC CODE	BARCODE
190076	Scraper Blades - for 190060	102mm X 18mm	0	10pc per pack	6	120	20861900769	
190069	Scraper Blades 10PC	38mm X 22mm	0	10pc per pack	20	240	20861900691	

# 42" Pneumatic Floor Scraper

Makes short work out of removing carpet glue, linoleum and tiles from kitchen and bathroom floors with its 4" wide blade. Featured with a paddle trigger and cushion grip for comfort and precision. This air scraper removes materials quickly and easily by generating up to 2,100 blows per minute. Its long reach and high power make it a must-have for your home remodeling needs.



Blade Width/Largeur de lame: 4"



**PLUS**  
1" WIDE BLADE  
LONG NOSE CHISEL

Air Consumption	5 SCFM @ 90 PSI Continuous Duty
Operating Air Pressure:	90 PSI
Blade Width/Largeur de lame:	1" & 4"
Maximum Speed:	2200 BPM
Air Inlet:	1/4"-18 NPT

ITEM #	DESCRIPTION	SIZE	MATERIAL/FINISH/HANDLE	FEATURES	INNER	MASTER	UPC CODE	BARCODE
130668	Pneumatic Floor Scraper Long Reach	4" x42"	Cushion Grip	Paddle Trigger	1	3	20861306684	

Floor Scraper HTS Blade w/Fiberglass Long Handle



ITEM #	SIZE	INNER	MASTER	UPC CODE	BARCODE
130665	8" x 48"	1	6	20861306653	

Floor Scraper HTS With Fiberglass Long Handle



ITEM #	SIZE	INNER	MASTER	UPC CODE	BARCODE
130666	12" x 48"	1	6	20861306660	

Floor Scraper HTS With Fiberglass Long Handle



ITEM #	SIZE	INNER	MASTER	UPC CODE	BARCODE
130667	6" x 48"	1	6	20861306677	

Floor Scraper Heavy Duty

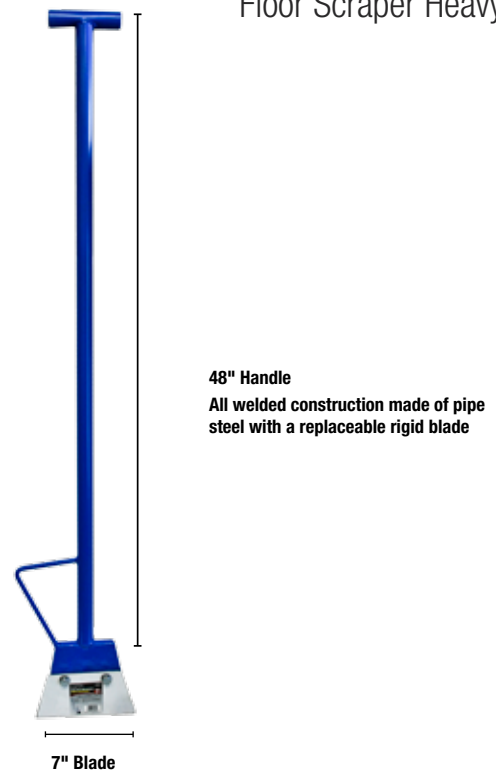

ITEM #	SIZE	INNER	MASTER	UPC CODE	BARCODE
130672	7" x 48"	1	3	20861306721	

Wood Block Plane



**INDUSTRIAL QUALITY**

- Fully adjustable
- The cutter is adjustable by means of a steel adjusting screw

ITEM #	SIZE	INNER	MASTER	UPC CODE	BARCODE
154375	7"	1	20	20861543751	

Smooth Block Plane



**INDUSTRIAL QUALITY**

- Hardwood handles
- Precision machined base
- Fully adjustable

ITEM #	SIZE	INNER	MASTER	UPC CODE	BARCODE
154376	10"	1	10	20861543768	

Surform (Pocket) Plane



- Die-casting alloy body
- Useful, one handed tool

ITEM #	SIZE	INNER	MASTER	UPC CODE	BARCODE
711753	5-1/2"	15	60	621457117532	

Surform Plane



- Two handles
- Precision shapes and smooths

ITEM #	SIZE	INNER	MASTER	UPC CODE	BARCODE
711754	11-1/4"	15	60	621457117549	

2pc Plane Set



Wood Smooth Plane | Rabet, Bois Lisse

711750



Handyman Block Plane  
Rabet de coupe d'usage général

ITEM #	SIZE	INNER	MASTER	UPC CODE	BARCODE
711750	2pc	1	10	621457117501	

Diamond Grit Whetstones



THREE DIFFERENT GRIT

ITEM #	SIZE	INNER	MASTER	UPC CODE	BARCODE
190101	3pc	1	24	20861901018	

Sharpening Stone White Aluminum Oxide



ITEM #	SIZE	INNER	MASTER	UPC CODE	BARCODE
191009		12	120	20861910096	

Sharpening Stone



ITEM #	SIZE	INNER	MASTER	UPC CODE	BARCODE
711240		12	240	621457112407	
711242	2pc	5	50	621457112421	
711246		6	60	621457112469	
711248		5	20	621457112483	



Drywall Rasp



ITEM #	SIZE	INNER	MASTER	UPC CODE	BARCODE
G05026	14 x 5.1 x 3.2 cm	4	16	84389050269	



Sharpening Stone For Laminate  
Cutter Blades



ITEM #	SIZE	INNER	MASTER	UPC CODE	BARCODE
191008		10	50	20861910089	

3PC "Pro" Wood Chisel Set



- 3pc Set**  
712522
- 1/2"
  - 3/4"
  - 1"



- 3pc Set**  
712523
- 1/2"
  - 3/4"
  - 1"

4PC Wood Chisel Set



- 4pc Set**  
712524
- 1/4"
  - 1/2"
  - 3/4"
  - 1"

ITEM #	SIZE	INNER	MASTER	UPC CODE	BARCODE
712522	1/2, 3/4, 1"	6	24	621457125223	
712523	1/2, 3/4, 1"	5	30	621457125230	

ITEM #	SIZE	INNER	MASTER	UPC CODE	BARCODE
712524	1/4, 1/2, 3/4, 1"	5	40	621457125247	

Yellow/Black Handle Wood Chisel



- High-quality, chrome vanadium steel blade.
- Rubber grip with non-slip design.
- Sturdy plastic sleeve.



Quick clip attaches to belt

- 125062 - • 1/2"
- 125063 - • 3/4"
- 125060 - • 1"
- 125061 - • 1-1/2"

Built-in sharpening stone

Individual in Plastic Pouch

ITEM #	SIZE	INNER	MASTER	UPC CODE	BARCODE
125062	1/2"	1	30	20861250628	
125063	3/4"	5	30	20861250635	
125060	1"	1	30	20861250604	
125061	1-1/2"	1	30	20861250611	

8pc Wood Turning Chisel Set



Contents

- Gouge 1/4"
- Skew 1"
- Gouge 1/2"
- Skew 2"
- Gouge 3/4"
- Point 1/2"
- Round Nose 1/2"
- Parting Tool 1/8"

Wooden handles  
Supplied in carrying Case



ITEM #	SIZE	INNER	MASTER	UPC CODE	BARCODE
712602	8pc	1	10	621457126022	

Brick & Block Chisel

Brick Bolster I  
Ciseau à Brique



**125040**

**Rubberized Grip Handles I**  
**Poignées caoutchoutées**

Shockproof, shatterproof, comfort grip hand protector

Brick Bolster I  
Ciseau à Brique



**125041**

**Rubberized Grip Handles I**  
**Poignées caoutchoutées**

Shockproof, shatterproof, comfort grip hand protector

Brick Bolster I  
Ciseau à Brique



**125042**

**Rubberized Grip Handles I**  
**Poignées caoutchoutées**

Shockproof, shatterproof, comfort grip hand protector

Cold Chisels I  
Ciseaux à Froid



**125043**

**Rubberized Grip Handles I**  
**Poignées caoutchoutées**

Shockproof, shatterproof, comfort grip hand protector

Cold Chisels I  
Ciseaux à Froid



**125044**

**Rubberized Grip Handles I**  
**Poignées caoutchoutées**

Shockproof, shatterproof, comfort grip hand protector

Cold Chisels I  
Ciseaux à Froid



**125045**

**Rubberized Grip Handles I**  
**Poignées caoutchoutées**

Shockproof, shatterproof, comfort grip hand protector

Point Chisels I  
Ciseaux à Froid



**125046**

**Rubberized Grip Handles I**  
**Poignées caoutchoutées**

Shockproof, shatterproof, comfort grip hand protector









Point Chisels I  
Ciseaux à Froid



**125047**

**Rubberized Grip Handles I**  
**Poignées caoutchoutées**

Shockproof, shatterproof, comfort grip hand protector

ITEM #	DESCRIPTION	LENGTH	SHANK	FEATURES	INNER	MASTER	UPC CODE	BARCODE
125040	Brick & Block Chisel W/Guard	9"	5/8"	2-1/4"	5	20	20861250406	
125041	Brick & Block Chisel W/Guard	9"	5/8"	3"	5	20	20861250413	
125042	Brick & Block Chisel W/Guard	9"	7/8"	4"	1	12	20861250420	
125044	Cold Chisel W/Guard	12"	5/8"	3/4"	5	20	20861250444	
125043	Cold Chisel W/Guard	10"	3/4"	7/8"	1	24	20861250451	
125045	Cold Chisel W/Guard	10"	7/8"	1"	5	20	20861250437	
125046	Point Chisel W/Guard	12"	3/4"	0	5	20	20861250468	
125047	Point Chisel W/Guard	12"	5/8"	0	5	20	20861250475	

### Chisel SDS Hammer Drill

Designed for chiseling and breaking work and is suitable for use on brick, concrete and loose stone. Heat-treated steel construction provides strength and durability.



125052



125053/125054

ITEM #	DESCRIPTION	LENGTH	SHANK	FEATURES	INNER	MASTER	UPC CODE	BARCODE
125052	Chisel SDS Hammer Drill Flat	6" / Flat	1/2"	Fits all SDS Plus machines	5	20	20861250529	
125053	Chisel SDS Hammer Drill Point	6" / Point	1-1/2"	Fits all SDS Plus machines	5	20	20861250536	
125054	Chisel SDS Hammer Drill Point	6" / Point	3/4"	Fits all SDS Plus machines	5	20	20861250543	

### Brick Chisel



ITEM #	DESCRIPTION	LENGTH	SHANK	FEATURES	INNER	MASTER	UPC CODE	BARCODE
G01324	Brick Chisel	7-1/2 x 2-1/4 x 3/4"	0	0	1	10	84389013240	

### Cold Chisel

### Pin Punch

### Solid Auger Punch

### Drift Punch

### Centre Punch



125001  
125002  
125003  
125004  
125005



125008  
125009  
125010



125012  
125013



125015  
125016



125018

ITEM #	DESCRIPTION	LENGTH	SHANK	FEATURES	INNER	MASTER	UPC CODE	BARCODE
125001	Cold Chisel	6"	3/8"	Black Oxide Finish	5	60	20861250017	
125002	Cold Chisel	6"	1/2"	Black Oxide Finish	5	30	20861250024	
125003	Cold Chisel	6-3/4"	5/8"	Black Oxide Finish	5	30	20861250031	
125004	Cold Chisel	7"	3/4"	Black Oxide Finish	5	30	20861250048	
125005	Cold Chisel	8-1/2"	1"	Black Oxide Finish	10	30	20861250055	
125008	Pin Punch	4-3/4"	1/8"	Black Oxide Finish	5	40	20861250086	
125009	Pin Punch	5-1/4"	3/16"	Black Oxide Finish	5	40	20861250093	
125010	Pin Punch	6"	1/4"	Black Oxide Finish	10	80	20861250109	
125012	Solid Auger Punch	6"	1/8"	Black Oxide Finish	6	60	20861250123	
125013	Solid Auger Punch	6"	3/16"	Black Oxide Finish	6	60	20861250130	
125015	Drift Punch	8"	1/8"	Black Oxide Finish	5	40	20861250154	
125016	Drift Punch	9"	3/16"	Black Oxide Finish	10	40	20861250161	
125018	Centre Punch	6"		Black Oxide Finish	6	60	20861250185	

**Workbench** Series 12PC Jumbo Punch & Chisel Set



- Includes / inclut
- 6 chisels / burins
  - 4 pin punches / coups d'épingle
  - 2 center punches / pointeaux

**Enamel finish to resist rust**  
**Hex shaped handles to prevent rolling**  
**Drop Forged Steel, Heat treated**

ITEM #	SIZE	INNER	MASTER	UPC CODE	BARCODE
712422	12pc	4	8	621457124226	

**Workbench** Series 12PC Pro Jumbo Punch & Chisel Set



- Includes / inclut
- 6 chisels / burins
  - 4 pin punches / coups d'épingle
  - 2 center punches / pointeaux

**Black oxide finish to resist corrosion**  
**Hex shaped handles to prevent rolling**  
**Drop Forged Steel, Heat treated**

ITEM #	SIZE	INNER	MASTER	UPC CODE	BARCODE
712425	12pc	4	8	621457124257	

**Workbench** Series 16 Pc Mechanics Punch & Chisel Set



- CR-V steel.
- Heat treated

- Includes / inclut
- (5) Taper Punches / Poinçons coniques
  - (5) Pin Punches / Coups d'épingle
  - (2) Center Punches / Pointeaux
  - (3) Cold Chisels / Burins
  - (1) Chisel Gauge / Jauge burin

ITEM #	SIZE	INNER	MASTER	UPC CODE	BARCODE
712406	16pc	5	20	621457124066	

**Workbench** Series 6 Pc Roll Pin Punch Set



- Chrome Vanadium 3/32", 1/8", 5/32", 3/16", 1/4", 5/16"

ITEM #	SIZE	INNER	MASTER	UPC CODE	BARCODE
712405	6pc	10	40	621457124059	

Number Punch Set

THE **Workbench**™ Series



ITEM #	SIZE	INNER	MASTER	UPC CODE	BARCODE
704604	4mm	25	50	621457046047	
704606	6mm	25	50	621457046061	
704608	8mm	25	50	621457046085	

Letter Punch Set

THE **Workbench**™ Series



ITEM #	SIZE	INNER	MASTER	UPC CODE	BARCODE
704624	4mm	10	30	621457046245	
704626	6mm	5	20	621457046269	
704628	8mm	5	10	621457046283	

38pc Number & Letter Stamping Set

THE **Workbench**™ Series



ITEM #	SIZE	INNER	MASTER	UPC CODE	BARCODE
704629	38pc	6	12	621457046290	

6PC Hollow Punch Set

THE **Workbench**™ Series



1/8", 5/32", 3/16", 1/4",  
5/16", 3/8"

ITEM #	SIZE	INNER	MASTER	UPC CODE	BARCODE
714026	6pc	10	60	621457140264	

12PC Hollow Punch Set

THE **Workbench**™ Series



1/8" 5/32" 3/16" 7/32" 1/4"  
5/16" 3/8" 7/16" 1/2" 9/16"  
5/8" 3/4"

ITEM #	SIZE	INNER	MASTER	UPC CODE	BARCODE
714027	12pc	5	20	621457140271	

3PC Nail Punch Set

THE **Workbench**™ Series



1/32", 1/16", 3/32", 1/8"

**INDUSTRIAL QUALITY**

ITEM #	SIZE	INNER	MASTER	UPC CODE	BARCODE
125050	3pc	10	80	20861250505	

Automatic Center Punch

THE **Workbench**™ Series



- Precision instrument
- No hammer required
- Alloy steel point
- Knurled steel body

ITEM #	SIZE	INNER	MASTER	UPC CODE	BARCODE
712402		12	120	621457124028	

4PC Nail Punch Set

THE **Workbench**™ Series

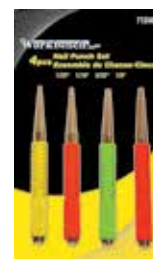

ITEM #	SIZE	INNER	MASTER	UPC CODE	BARCODE
712403	4pc	10	100	621457124035	

**THE Workbench™ Series**

Scratch Awl



ITEM #	SIZE	INNER	MASTER	UPC CODE	BARCODE
712401		12	240	621457124011	

Hand Riveter



ITEM #	SIZE	INNER	MASTER	UPC CODE	BARCODE
706030	10.5"	8	40	621457060302	

Pliers Eyelet With 50 Eyelets



- For belts shower curtains tote bags and pillows
- Use eyelets to create laced effects on garments and craft projects

ITEM #	SIZE	INNER	MASTER	UPC CODE	BARCODE
714053	50pc	1	50	621457140530	

Hand Riveter HD



ITEM #	SIZE	INNER	MASTER	UPC CODE	BARCODE
706031	11"	6	24	621457060319	

**THE Workbench™ Series**

Revolving Leather Punch



- Punch wheel rotates to switch between punch sizes
- Cushioned, anti-slip grips
- Includes six hollow bell punches

ITEM #	SIZE	INNER	MASTER	UPC CODE	BARCODE
714021	5/64" - 3/16"	12	72	621457140219	

Pantograph Hand Riveter



ITEM #	SIZE	INNER	MASTER	UPC CODE	BARCODE
706032	32"	6	12	621457060326	

**THE Workbench™ Series**

Revolving Leather Punch HD



- 5/64, 3/32, 1/8, 9/64, 5/32, 11/64"
- 2, 2.5, 3, 3.5, 4, 5mm

ITEM #	SIZE	INNER	MASTER	UPC CODE	BARCODE
714022	5/64" - 3/16"	6	36	621457140226	

Hand Riveter Kit



ITEM #	SIZE	INNER	MASTER	UPC CODE	BARCODE
714042		10	20	621457140424	
307442		6	24	773544074423	

Files | Limes



711361



711362



711363



711364



711365



711381  
711382  
711383



711384



711385



711386  
711387



711388



711389



711391



711392

ITEM #	DESCRIPTION	SIZE	MATERIAL/FINISH/HANDLE	FEATURES	INNER	MASTER	UPC CODE	BARCODE
711361	Flat File With Handle	8"	0	0	10	100	621457113619	
711362	Square File With Handle	8"	0	0	10	100	621457113626	
711363	Round File With Handle	8"	0	0	10	100	621457113633	
711364	Half Round File w/Handle	8"	0	0	10	100	621457113640	
711365	Triangle File With Handle	8"	0	0	10	100	621457113657	
711381	Flat Saw File - Bastard Cut	6"	0	0	10	200	621457113817	
711382	Flat Saw File - Bastard Cut	8"	0	0	10	100	621457113824	
711383	Flat Saw File - Bastard Cut	10"	0	0	10	80	621457113831	
711384	Flat Axe File	8"	0	0	10	80	621457113848	
711385	Flat Farmers' File	10"	0	0	10	60	621457113855	
711386	Round File - Bastad Cut	8"	0	0	10	100	621457113862	
711387	Round File - Bastad Cut	10"	0	0	10	80	621457113879	
711388	Half Round File - Bastard Cut	8"	0	0	10	100	621457113886	
711389	Triangle Saw File	6"	0	0	10	200	621457113893	
711391	Half Round Rasp	8"	0	0	10	80	621457113916	
711392	Four In One Rasp	8"	0	0	10	100	621457113923	



6PC Precision File Set



154379

6PC Needle File Set



711302

12PC Needle File Set



711305, 711306

File Sets

10PC Riffler File Set



711312

5PC Steel File Set with Handle



711325

12PC Steel File Set with Handle



711328

3PC Wood Rasp File Set



711343

6PC Steel File Set with Handle



390077

ITEM #	DESCRIPTION	SIZE	MATERIAL/FINISH/HANDLE	FEATURES	INNER	MASTER	UPC CODE	BARCODE
154379	Precision File 6 PC Set	6pc	-		6	48	20861543799	
711302	6 PC Needle File Set	160mm	-		10	100	621457113022	
711305	12PC Needle File Set	160mm	-		10	100	621457113053	
711306	12PC Needle File Set	180mm	-		10	100	621457113060	
711312	10PC Riffler File Set	180mm	-		10	100	621457113121	
711325	5PC Steel File Set with Handle	8"	-		10	40	621457113251	
711328	12PC Steel File Set with Handle	10"	-	Wood File Set	10	20	621457113282	
711343	3PC Wood Rasp File Set	8"	-		10	40	621457113435	
390077	File 6PC Set With Handles	6pc	-		6	12	773544900777	



Chain Saw Files



ITEM #	SIZE	INNER	MASTER	UPC CODE	BARCODE
711371	1/8" x 8"	12	300	621457113718	
711372	5/32" x 8"	20	400	621457113725	
711373	3/16" x 8"	20	400	621457113732	
711374	13/64" x 8"	12	300	621457113749	
711375	7/32" x 8"	20	400	621457113756	



Tile File



ITEM #	SIZE	INNER	MASTER	UPC CODE	BARCODE
G02122	15.2 x 2.5 x 0.6 cm	1	8	84389021221	

Wire Brush 4 Row Steel



723024

162002



12pc Display Box!

ITEM #	SIZE	INNER	MASTER	UPC CODE	BARCODE
733024	4 Row	12	48	621457330245	
162002	5 Row	12	72	20861620025	

Wire Brush With Scraper Soft Grip Handle



Heavy-duty scraper



162012



ITEM #	SIZE	INNER	MASTER	UPC CODE	BARCODE
162012		6	36	20861620124	

Wire Brush 6 Row



162003



12pc Display Box!

ITEM #	SIZE	INNER	MASTER	UPC CODE	BARCODE
162003	6 Row	12	120	20861620032	

Wire Brush With Scraper SS



161006

ITEM #	SIZE	INNER	MASTER	UPC CODE	BARCODE
161006		12	72	20861610064	

Wire Brush 4 Row Steel With Scraper



Heavy-duty scraper



733033

ITEM #	SIZE	INNER	MASTER	UPC CODE	BARCODE
733033	4 Row	6	48	621457330337	

Wire Brush 4 Row Plastic Handle



ITEM #	SIZE	INNER	MASTER	UPC CODE	BARCODE
162007	4 Row	12	72	20861620070	

**THE Workbench™ Series**

Wire Brush

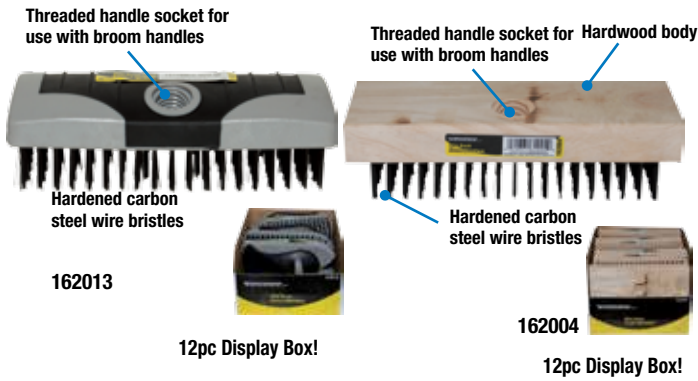

ITEM #	SIZE	INNER	MASTER	UPC CODE	BARCODE
162013	7 Row	6	36	20861620131	
162004	7 Row	12	72	20861620049	

**THE Workbench™ Series**

Wire Brush

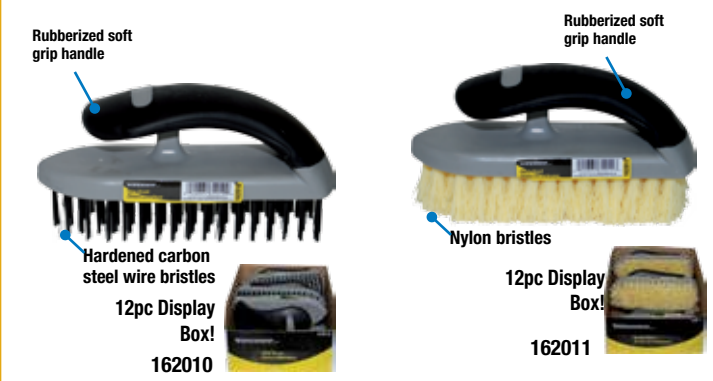

ITEM #	SIZE	INNER	MASTER	UPC CODE	BARCODE
162010	5 x 18 Row	1	36	20861620100	
162011	5 x 18 Row	1	36	20861620117	

**THE Workbench™ Series**

3PC Wire Brush Set



ITEM #	SIZE	INNER	MASTER	UPC CODE	BARCODE
733021	7"	25	100	621457330214	
733022	9"	12	48	621457330221	

**THE Workbench™ Series**

3PC Wire Brush Soft Grip Set

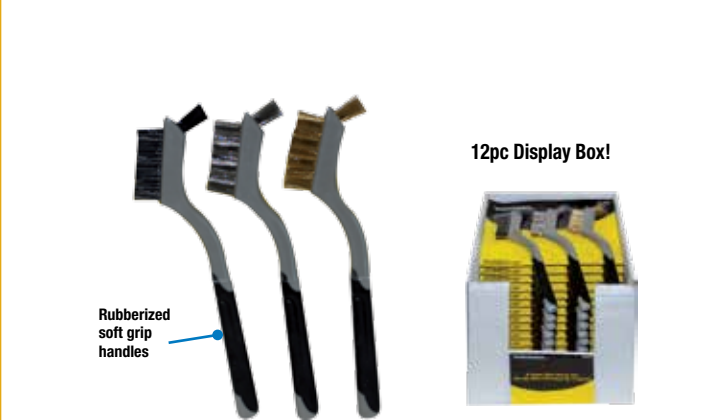

ITEM #	SIZE	INNER	MASTER	UPC CODE	BARCODE
733020	3pc	12	144	621457330207	

**THE Workbench™ Series**

BBQ Wire Brush

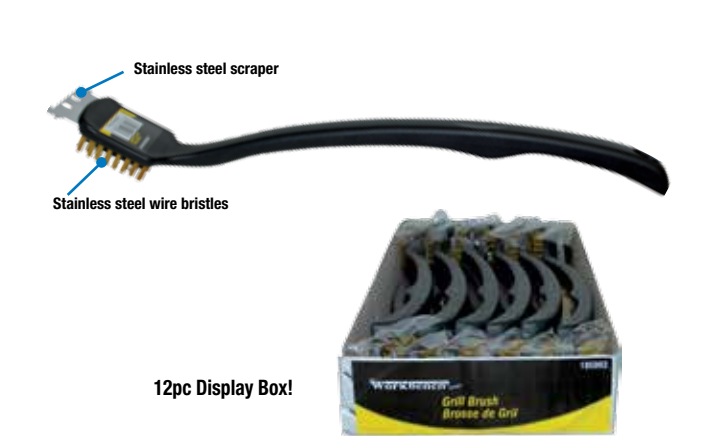

ITEM #	SIZE	INNER	MASTER	UPC CODE	BARCODE
185003		12	72	20861850033	

**THE Workbench™ Series**

Wire Brush Knife Style



ITEM #	SIZE	INNER	MASTER	UPC CODE	BARCODE
161008	3pc	12	72	20861610088	

Aluminum Bar Clamp



- Aluminum Bar Clamps**
- Torsion box design combines rigidity with light weight
  - Spring loaded quick action clamp head

Aluminum Bar Clamps | Serre-Joints en Aluminium

ITEM #	MFG#	SIZE	INNER	MASTER	UPC CODE	BARCODE
716053	0	36"	1	10	621457160538	
716054	0	48"	1	10	621457160545	
716057	0	72"	1	10	621457160576	

Sliding Wood Bar Clamp - F



- F-Bar Clamps**
- Reinforced cast jaws
  - Serrated edges to prevent slipping
  - I-Beam to prevent buckling

ITEM #	MFG#	SIZE	INNER	MASTER	UPC CODE	BARCODE
154380	0	50 x 100	1	20	20861543805	
154381	0	50 x 150	1	50	20861543812	
154382	0	80 x 200	1	20	20861543829	
154383	0	80 x 400	1	20	20861543836	
154384	0	120 x 600	1	10	20861543843	
154385	0	120 x 800	1	10	20861543850	
154386	0	120 x 1200	1	8	20861543867	

Quick Action Bar Clamp

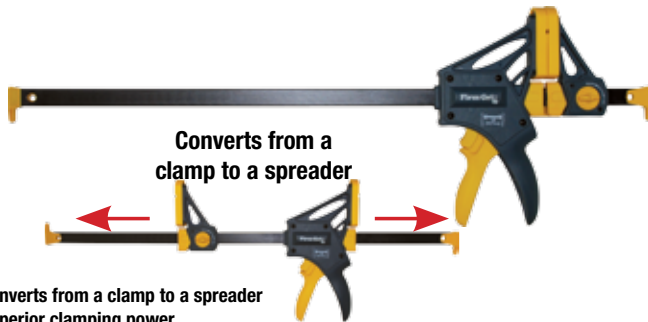

Converts from a clamp to a spreader

- Converts from a clamp to a spreader
- Superior clamping power
- Forward and reverse triggers adjust clamp pad in small increments for easy one-handed operation
- Jaw is easily removed to convert clamp to spreader
- Non-marking pads protect workpiece

ITEM #	MFG#	SIZE	INNER	MASTER	UPC CODE	BARCODE
154354	0	4"	12	120	20861543546	
716013	0	8"	1	8	621457160132	
716014	0	12"	1	8	621457160149	
716015	0	18"	1	8	621457160156	
716016	0	24"	1	8	621457160163	
716017	0	36"	1	8	621457160170	

Quick Action Bar Clamp



ITEM #	SIZE	INNER	MASTER	UPC CODE	BARCODE
394530	4"	12	72	773544945303	
394531	6"	6	36	773544945310	
394532	12"	6	36	773544945327	
394533	24"	6	24	773544945334	

**Firm Gri<sub>ps</sub>**

C-Clamp



- Durable cast construction
- Reinforced corners
- Chrome plated A3 steel screw
- Large swivel pad
- Sliding T-Bar Handle

ITEM #	SIZE	INNER	MASTER	UPC CODE	BARCODE
716021	1"	12	48	621457160217	
394400	1"	6	36	773544944009	
394401	2"	6	36	773544944016	
394402	2 1/2" x 1 1/2"	6	36	773544944023	
394403	2 1/2" x 2 1/2"	6	36	773544944030	
394404	3"	6	36	773544944047	
394405	4"	3	36	773544944054	
716025	5"	1	6	621457160255	
394406	5"	3	24	773544944061	
394407	6"	3	24	773544944078	
716030	8"	1	6	621457160309	

**Firm Gri<sub>ps</sub>**

C-Clamp V-Jaw



ITEM #	SIZE	INNER	MASTER	UPC CODE	BARCODE
716027	3"	3	18	621457160279	
394409	4"	4	8	773544944092	
716029	6"	2	12	621457160293	

**Firm Gri<sub>ps</sub>**

3PC C-Clamp



ITEM #	MFG#	SIZE	INNER	MASTER	UPC CODE	BARCODE
154370	0	1, 2, 3"	6	24	20861543706	

**Firm Gri<sub>ps</sub>**

Adjustable C-Clamp



- Push button for quick adjustable jaw opening

Available in a 6pc Display Box!

ITEM #	MFG#	SIZE	INNER	MASTER	UPC CODE	BARCODE
716032	0	2" - 3"	6	6	621457160323	
716033	0	4" - 7"	10	100	621457160330	

Sliding Bar Clamp F



ITEM #	SIZE	INNER	MASTER	UPC CODE	BARCODE
394508	8"	6	36	773544945082	

Clamp & Saw Guide Device



154392, 154393

- 3-Position cam lock action for stronger hold
- Powerful nylon jaws with rubber insert for stronger grip
- Rigid, non-twist anodized aluminum channel with steel tension-carrying rod

ITEM #	MFG#	SIZE	INNER	MASTER	UPC CODE	BARCODE
154392	0	24"	1	24	20861543928	
154393	0	36"	1	12	20861543935	

Ratcheting Bar Clamp



ITEM #	SIZE	INNER	MASTER	UPC CODE	BARCODE
394606	6"	6	36	773544946065	
394612	12"	6	36	773544946126	
394618	18"	6	24	773544946188	
394624	24"	6	24	773544946249	
394636	36"	6	12	773544946362	

Clamp & Saw Guide Device



154394, 154396

- 3-Position cam lock action for stronger hold
- Powerful nylon jaws with rubber insert for stronger grip
- Rigid, non-twist anodized aluminum channel with steel tension-carrying rod

ITEM #	MFG#	SIZE	INNER	MASTER	UPC CODE	BARCODE
154394	0	50"	1	12	20861543942	
154396	0	97"	1	10	20861543966	



4PC Mini Spring Clamp Set



ITEM #	SIZE	INNER	MASTER	UPC CODE	BARCODE
716083	4pc - Mini	10	100	621457160835	
716084	4pc - 4"	50	100	621457160842	



Spring Clamp



ITEM #	SIZE	INNER	MASTER	UPC CODE	BARCODE
394692	3/4"	90	360	773544946928	
394693	10pc Set	1	72	773544946935	



Steel Spring Clamp



389508 - 100 pc

ITEM #	SIZE	INNER	MASTER	UPC CODE	BARCODE
394694	1"	6	36	773544946942	
394696	2"	6	36	773544946966	
394699	3"	6	36	773544946997	
389508	3/4"	100	400	773544895080	



Flex Jaw Spring Clamp



394712 - 14pc

ITEM #	SIZE	INNER	MASTER	UPC CODE	BARCODE
394701	1"	1	36	773544947017	
394702	2"	1	36	773544947024	
394703	3"	1	36	773544947031	
394712	14pc	1	40	773544947123	



4PC Micro Flex Jaw Spring Clamps



ITEM #	SIZE	INNER	MASTER	UPC CODE	BARCODE
394704	4pc	1	36	773544947048	



40pc Mini Spring Clamp Set



ITEM #	SIZE	INNER	MASTER	UPC CODE	BARCODE
389500	3/4"	40	160	773544895004	

Ratcheting Clamp (Round Jaw)



- Ratcheting mechanism provides adjustable clamping pressure
- Significantly reduces hand force required to generate clamping pressure
- Fast release trigger allows for fast and easy positioning and release
- Heavy duty plastic body and zinc alloy ratchet

Round Grip

ITEM #	SIZE	INNER	MASTER	UPC CODE	BARCODE
716090	6"	12	96	621457160903	
716091	8"	12	48	621457160910	

Ratcheting Clamp (Oval Jaw)



- Ratcheting mechanism provides adjustable clamping pressure
- Significantly reduces hand force required to generate clamping pressure
- Fast release trigger allows for fast and easy positioning and release
- Heavy duty plastic body and zinc alloy ratchet

Deep Grip

ITEM #	SIZE	INNER	MASTER	UPC CODE	BARCODE
716092	6-1/4"	12	96	621457160927	
716093	9"	12	48	621457160934	

Flex Jaw Ratcheting Clamp



ITEM #	SIZE	INNER	MASTER	UPC CODE	BARCODE
394715	2"	6	36	773544947154	
394716	3"	6	36	773544947161	
394717	1-1/2"	6	36	773544947178	

Corner Vise Clamp



- Clamp Different Thickness
- Pass Through Joints
- Miter Joints
- "V" Groove for Round Stock
- Swivel Handle

ITEM #	SIZE	INNER	MASTER	UPC CODE	BARCODE
796405		6	24	621457964051	

Gluing Clamp



ITEM #	SIZE	INNER	MASTER	UPC CODE	BARCODE
394689	1/2"	4	16	773544946898	
394690	3/4"	3	12	773544946904	

Corner Clamp 90 Degree



ITEM #	SIZE	INNER	MASTER	UPC CODE	BARCODE
394654	90 degree	6	36	773544946546	

Quick Adjust Aluminum Clamps



Quick Adjust Aluminum Clamps



ITEM #	SIZE	INNER MASTER	UPC CODE	BARCODE
796403		1 20	621457964037	

ITEM #	SIZE	INNER MASTER	UPC CODE	BARCODE
796404		1 20	621457964044	

Drill Press Vises



Drill Press Vises



Quick release feature permits rapid opening and closure of the jaws or use the handle to make small adjustments

Quick release feature permits rapid opening and closure of the jaws or use the handle to make small adjustments

Aluminum Quick Adjust

Aluminum Quick Adjust

ITEM #	SIZE	INNER MASTER	UPC CODE	BARCODE
796401		1 20	621457964013	

ITEM #	SIZE	INNER MASTER	UPC CODE	BARCODE
796402		1 10	621457964020	

Drill Press Vise

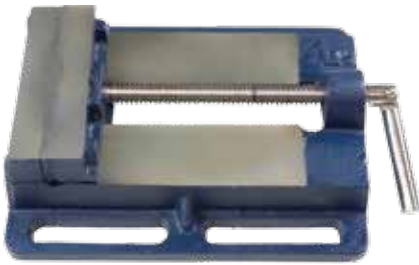

Easy Mounting Slots And Unique Pivot Handle Design For Extra Clamping Pressure

Forged Cast

ITEM #	SIZE	INNER	MASTER	UPC CODE	BARCODE
717023	3"	1	10	621457170230	
717024	4"	1	10	621457170247	
717025	5"	1	5	621457170254	
717026	6"	1	5	621457170261	

Clamp-On Vise - Multi-Function



Head Rotates 360° and Tilts 45°

- Lets you work comfortably at any angle
- Easily secured to a work surface

ITEM #	SIZE	INNER	MASTER	UPC CODE	BARCODE
796411		1	20	621457964112	

1/2" Pipe Gluing Clamp



- Used for clamping woodworking for gluing

ITEM #	SIZE	INNER	MASTER	UPC CODE	BARCODE
716045	1/2"	4	24	621457160453	

Adjustable Band Clamp



- Nylon band
- Clamp odd-shapes with or without braces
- Position clamps securely, ensuring adequate pad surface contact

ITEM #	SIZE	INNER	MASTER	UPC CODE	BARCODE
796601		1	20	621457966017	

Clamp-On Vise - Multi-Function



Clamp-On Vise - Multi-Function

ITEM #	SIZE	INNER	MASTER	UPC CODE	BARCODE
796412		1	12	621457964129	

Deep Throat - Pipe Clamp.



- 3/4" Pipe Holding, Woodworking, Gluing

ITEM #	SIZE	INNER	MASTER	UPC CODE	BARCODE
716038	3/4"	1	12	621457160385	

THE **Workbench**™ Series

Bench Vise Steel With Swivel Base

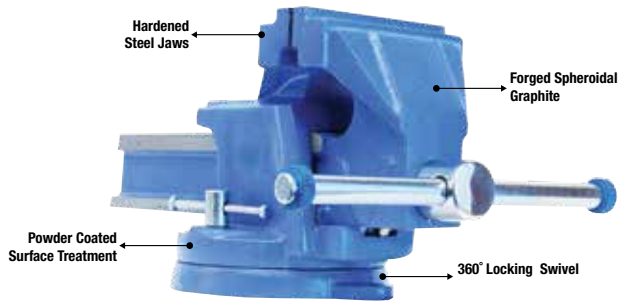

Steel Bench vise with Swivel Base

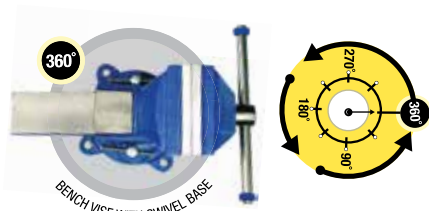

ITEM #	SIZE	INNER	MASTER	UPC CODE	BARCODE
717120	4"	1	1	621457171206	
717122	6"	1	1	621457171220	

THE **Workbench**™ Series

Homeowners Bench Vise



ITEM #	SIZE	INNER	MASTER	UPC CODE	BARCODE
399435	3 1/2"	1	6	773544994356	

THE **Workbench**™ Series

Machinist Swivel Bench Vise



ITEM #	SIZE	INNER	MASTER	UPC CODE	BARCODE
399443	3"	1	2	773544994431	
399444	4"	1	2	773544994448	
399445	5"	1	1	773544994455	
399446	6"	1	1	773544994462	

THE **Workbench**™ Series

MuLi-Functional Bench Vise



ITEM #	SIZE	INNER	MASTER	UPC CODE	BARCODE
399447	5"	1	1	74972994476	

Mini Tubing Cutter - Cuts Copper



ITEM #	SIZE	INNER	MASTER	UPC CODE	BARCODE
713021	1/8~5/8"	24	144	621457130210	

Tubing Cutter - Industrial Quality



- 191030**
- Cuts copper; brass; aluminum tubing and thin wall conduit.
  - Heavy-duty one piece slide.
  - Grooved rolls for close to flare cuts.
  - Includes spare cutter wheel in handle.

ITEM #	SIZE	INNER	MASTER	UPC CODE	BARCODE
191030	1/8~1-1/4"	4	60	208619103000	

Tubing Cutter Mini - Cuts Copper



ITEM #	SIZE	INNER	MASTER	UPC CODE	BARCODE
191034	1/8~7/8"	6	100	20861910348	

Tubing Cutter - Industrial Quality



- 191031**
- Cuts copper, brass, aluminum tubing & thin-wall conduit.
  - Tool steel cutting wheel for strength and durability.
  - Wheel in the handle cuts PVC plastic pipe.
  - Deburring reamer inside handle.
  - Spring loaded cutting wheel mechanism allows fast sliding into position and quick release.

ITEM #	SIZE	INNER	MASTER	UPC CODE	BARCODE
191031	1/8~2-1/2"	6	36	20861910317	

Tubing Cutter - Cuts Copper



ITEM #	SIZE	INNER	MASTER	UPC CODE	BARCODE
191036	1/8~1-1/8"	12	48	20861910362	

Tubing Cutter - Industrial Quality



- 191032**
- Cuts copper, brass, aluminum tubing & thin-wall conduit.
  - Tool steel cutting wheel for strength and durability.
  - Spring loaded cutting wheel mechanism allows fast sliding into position and quick release.

ITEM #	SIZE	INNER	MASTER	UPC CODE	BARCODE
191032	1/4~2"	6	48	20861910324	

**THE Workbench<sup>SM</sup> Series** Tubing Cutter Mini - Cuts Copper



ITEM #	SIZE	INNER	MASTER	UPC CODE	BARCODE
392714	1/8"-7/8"	1	36	74972927146	

**THE Workbench<sup>SM</sup> Series** Tubing Cutter - Cuts Copper



ITEM #	SIZE	INNER	MASTER	UPC CODE	BARCODE
392710	1/8" - 1-1/8"	6	36	74972927108	

**THE Workbench<sup>SM</sup> Series** Tube Cutter Heavy Duty - Cuts Copper



ITEM #	SIZE	INNER	MASTER	UPC CODE	BARCODE
330103		6	36	773544301031	

**THE Workbench<sup>SM</sup> Series** Tubing Cutter & Replacement Wheel



191040

191038 - 191039 - 991031

ITEM #	SIZE	INNER	MASTER	UPC CODE	BARCODE
191040	22mm	10	50	20861910409	
191038		1	50	20861910386	
191037		1	50	20861910379	
991031		25	200	20869910319	

**THE Workbench<sup>SM</sup> Series** Pex-PVC Pipe Cutter



Spring loaded handles for faster positioning

ITEM #	SIZE	INNER	MASTER	UPC CODE	BARCODE
191048	33mm / 1-1/4"	10	50	20861910485	

**THE Workbench<sup>SM</sup> Series** Pex-PVC Pipe Cutter Ratchet Type



ITEM #	SIZE	INNER	MASTER	UPC CODE	BARCODE
191049	42mm / 1-1/2"	10	50	20861910492	

Pex Crimping Tool

- 191042 Includes:
- One PEX Crimp Tool for 1/2" PEX Pipe
  - Go/ No-Go Sizing Gauge
  - Crimp Adjustment Wrench
- Meets ASTM 1807 Standard



- 191044 Includes:
- One PEX Crimp Tool for 3/4" PEX Pipe
  - Go/ No-Go Sizing Gauge
  - Crimp Adjustment Wrench
- Meets ASTM 1807 Standard



- 191041
- Removes PEX Rings (Works on 1/2" - 1" Pex Rings)
  - Makes Fittings Reusable
  - Meets ASTM 1807 Standard
  - Fast and Easy Crimp Ring



ITEM #	SIZE	INNER	MASTER	UPC CODE	BARCODE
191042	1/2"	1	10	20861910423	
191044	3/4"	1	10	20861910447	
191041	1/2" - 1"	5	50	20861910416	

Flaring Tool Set - Double Type



713062

ITEM #	SIZE	INNER	MASTER	UPC CODE	BARCODE
713062		1	20	621457130623	

Flaring Tool Set



ITEM #	SIZE	INNER	MASTER	UPC CODE	BARCODE
713061		6	24	621457130616	

Pipe Bender



ITEM #	SIZE	INNER	MASTER	UPC CODE	BARCODE
713032		6	36	621457130326	

Pex Crimping Tool



- 191050 Includes:
- 2 Cavity design eliminates the need for 2 tools
  - Tools are supplied with Go/No Go gauge
  - Soft-Touch



- 191051 Includes:
- Crimping range: 1/2"
  - Comes with a go/no-go sizing gauge
  - Angled head for use in tight spots
  - Long handle with rubber grip for less hand fatigue



- 191043 Includes:
- Four Interchangeable Jaws - 3/8", 1/2", 3/4", and 1"
  - Durable Plastic Case for Protection and Easy Storage
  - Go/ No-Go Gauge to Ensure Proper Cinch Compression
  - Adjustment Wrench for Jaw Replacement and Tool Adjustment
  - Blow-Molded Grips for better comfort!



ITEM #	DESCRIPTION	SIZE	MATERIAL/FINISH/HANDLE	FEATURES	INNER	MASTER	UPC CODE	BARCODE
191050	Pex Combo Crimp Tool	1/2" & 3/4"	0	0	1	10	20861910508	
191051	Pex Combo Crimp Tool	1/2"	0	0	5	30	20861910515	
191043	Pex Multi-Head Crimp	3/8", 1/2", 3/4", 1"	0	0	3	6	20861910430	



GREAT DEALS ON HANDS TOOLS & ACCESSORIES

**SHOP NOW & SAVE!**

Providing many of the world's most reliable and best-performing professional-grade tools



Claw Hammers

80062361  
80062461

Curved Claw  
Nylon-Vinyl  
Grip

80061141  
80061201

Curved Claw  
Leather Grip



Framing Hammers  
Mill Face

All Steel Handle  
w/Nylon-Vinyl Grip



80062661 - Milled Face

ITEM #	MFG#	SIZE	INNER	MASTER	UPC CODE	BARCODE
80062361	E316C	16oz x 13.5"	2	24	34139623618	
80062461	E320C	20oz x 13.5"	4	24	34139624615	
80061141	E16C	16oz x 13.5"	4	24	34139611417	
80061201	E20C	20oz x 13.5"	4	24	34139612018	

ITEM #	MFG#	SIZE	INNER	MASTER	UPC CODE	BARCODE
80062681	E322SMR	22oz x 13.5"	4	24	34139626817	
80062661	E322SM	22oz x 16"	2	20	34139626619	



Rip Hammers

80062381  
80062501

Straight Claw  
Nylon-Vinyl  
Grip

80061161  
80061221

Straight Claw  
Leather Grip



Framing Hammers  
Smooth Face

All Steel Handle  
w/Nylon-Vinyl Grip

ITEM #	MFG#	SIZE	INNER	MASTER	UPC CODE	BARCODE
80062381	E316S	16oz	4	24	34139623816	
80062501	E320S	20oz	4	24	34139625018	
80061161	E16S	16oz	4	24	34139611615	
80061221	E20S	20oz	4	24	34139612216	

ITEM #	MFG#	SIZE	INNER	MASTER	UPC CODE	BARCODE
80062701	E322SR	22oz x 13.5"	4	24	34139627012	
80062641	E322S	22oz x 16"	2	20	34139626411	
80062801	E324S	24oz x 16"	4	20	34139628019	
80062881	E328S	28oz x 16"	2	20	34139628811	
80062921	E330S	30oz x 16"	4	20	34139629214	



Drywall Hammer

All Steel Handle  
w/Nylon-Vinyl Grip

ITEM #	MFG#	SIZE	INNER	MASTER	UPC CODE	BARCODE
80062221	E311	11oz	2	24	34139622215	

**CLAW AND RIP HAMMERS WITH SHOCK REDUCTION GRIP**

**Estwing**

Durable, Comfortable Striking Tools Since 1923

Brick Hammers



Wood Handle



ITEM #	MFG#	SIZE	INNER	MASTER	UPC CODE	BARCODE
80054435	54-435	24oz	4	24	76174544350	
88001229	D22400	24oz	1	4	64730012290	

Bricklayer Hammer



Wood Handle

80062770



All Steel Handle w/Nylon-Vinyl Grip

80062771



ITEM #	MFG#	SIZE	INNER	MASTER	UPC CODE	BARCODE
80062770	EW6-21BL	21oz	2	12	34139627708	
80062771	E324BLC	24oz	4	24	34139627715	

Shingler's Hatchet with Vinyl Grip



All Steel Handle w/Nylon-Vinyl Grip



ITEM #	MFG#	SIZE	INNER	MASTER	UPC CODE	BARCODE
80062141	E3S	2.63lbs	4	24	34139621416	

13-1/2lb Sportsman's Axe (With Sheath)



Leather Grip 3/4" Cutting Edge



ITEM #	MFG#	SIZE	INNER	MASTER	UPC CODE	BARCODE
80061241	E24A	13.5lbs	2	24	34139612414	

Club Hammers



10" Hickory Handle



ITEM #	MFG#	SIZE	INNER	MASTER	UPC CODE	BARCODE
88001213	D10004	3lbs	1	4	64730012139	
88001215	D10104	4lbs	1	4	64730012153	

Steel Wedges - Barbed Edge - 2pc



ITEM #	MFG#	SIZE	INNER	MASTER	UPC CODE	BARCODE
80008061	8061	Medium	20	400	6639508014	
80008062	8062	Large	20	200	66395080621	



Replacement Handles



88000907	88001517	88000862	88000871	88000880	88001179	88001182	88000477	88086986	88000772 88000726	88000737	88001192	88001195
Mason club hammer handle, varnished hickory. Fits: all mason club hammer, American eye.					Premium ashwood handle with steel D-grip	Poly D-grip (steel/wood) shovel handle with 2 rivets.	Single bit axe handle, American eye, men's size, varnished hickory.	Pick handle, premium varnished hickory. Fits standard pick heads.	Large Canadian eye sledge hammer handle, waxed hickory	Sledge hammer handle, waxed hickory.	Firefighter shovel handle (with 2 rivets).	Long shovel ash handle 48", varnished long ash handle.

ITEM #	MFG#	DESCRIPTION	SIZE	MATERIAL/FINISH/HANDLE	FEATURES	INNER	MASTER	UPC CODE	BARCODE
88000907	B4031005	Club Hammer	10"	Hickory handle	Replacement Handles	1	6	64730009078	
88001517	B4111201	Brick Hammer	12"	Hickory handle	Replacement Handles	1	6	64730015178	
88000862	B4021205	Ball Pien Hammer	12"	Hickory handle	Replacement Handles	1	6	64730008620	
88000871	B4021405	Ball Pien Hammer	14"	Hickory handle	Replacement Handles	1	6	64730008712	
88000880	B4021605	Ball Pien Hammer	16"	Hickory handle	Replacement Handles	1	6	64730008804	
88001179	C4512409	Shovel D-Handle	24"	Ashwood handle	Replacement Handles	1	4	64730011798	
88001182	C4512809	Shovel D-Handle	28"	Hickory handle	Replacement Handles	1	4	64730011828	
88000477	B1003605	Axe Handle	36"	Hickory handle	Replacement Handles	1	6	64730004776	
88086986	B6053601	Pick Handle	36"	Hickory handle	Replacement Handles	1	4	64730869863	
88000772	B3013606	Sledge Handle	36"	Hickory handle	Replacement Handles	1	6	64730007722	
88000726	B3003206	Sledge Handle	32"	Hickory handle	Replacement Handles	1	6	64730007265	
88000737	B3003606	Sledge Handle	36"	Hickory handle	Replacement Handles	1	6	64730007371	
88001192	C4554009	Shovel Handle (Long)	40"	Hickory handle	Replacement Handles	1	4	64730011927	
88001195	C4564809	Shovel Handle (Long)	48"	Ashwood handle	Replacement Handles	1	6	64730011958	

Handy Bar



ITEM #	MFG#	SIZE	INNER	MASTER	UPC CODE	BARCODE
80064001	HB-15	15"	4	48	34139640011	

Handy Claw



ITEM #	MFG#	SIZE	INNER	MASTER	UPC CODE	BARCODE
80063001	HC10	10"	2	48	34139630012	

Wonder Bar



ITEM #	MFG#	SIZE	INNER	MASTER	UPC CODE	BARCODE
80055515	55-515	12-3/4"	4	24	76174555158	

3-IN-1 Pro-Claw Construction Bar



ITEM #	MFG#	SIZE	INNER	MASTER	UPC CODE	BARCODE
80010441	RSC	16.8"	1	2	34139104414	

Truly a unique patented roofing, siding, contractor bar. Drop forged from fine tool steel, one end has a thin blade with a 2 1/2 in.

Nut Driver 3PC Box Set  
T-Handle



The T-Handle Nut Driver features 15 different sizes of nut driver (8 Metric and 7 Imperial sizes) that are designed to provide high torque transmission from hand to nut or bolt. The forged steel shank has superior strength and the t-handle design provides additional leverage for great torque when handling tough nuts and bolts. Laser welded construction allows up to 70Nm torque or 620 inch pounds.

ITEM #	MFG#	SIZE	INNER	MASTER	UPC CODE	BARCODE
80000952	9TND-3P	3pc	1	1	831044009526	



**GREAT SAVING ON QUALITY WRECKING BARS**

### MegaPro Original 15-in-1 Screwdriver

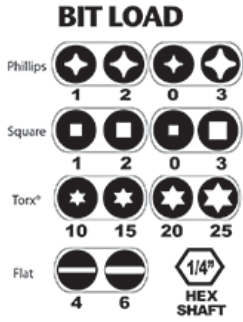

The MEGAPRO Original 15-in-1 Screwdriver has industrial-grade torx, square, hex, slotted and phillips screwdriver bit sizes combined into one. This all-purpose multi-bit screwdriver is our most popular seller. Loaded with 7 double end professional quality bits, this assortment of bit types and sizes provides the 14 most popular tips for driving screws. The shaft opening serves as a 1/4" hex driver! Hence the name "15-in-1".



ITEM #	MFG#	DESCRIPTION	SIZE	MATERIAL/FINISH/HANDLE	FEATURES	INNER	MASTER	UPC CODE	BARCODE
501202	151NAS	Screwdriver MegaPro	15 in 1	Original	Ratcheting Screwdriver	1	25	831044012021	

**BIT LOAD**

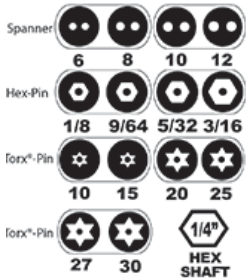

### MegaPro Tamperproof Screwdriver

The Tamperproof spanner screwdriver is a complete security screwdriver set in one driver. This 15-in-1 screwdriver is a must for all commercial and industrial tradesmen including electricians, locksmiths, telephone technicians, maintenance personnel, etc. The Tamperproof assortment includes the most popular security bits: various sizes of Spanners, Hex Pins and Torx Pins. The shaft opening also serves as a 1/4" hex driver!



ITEM #	MFG#	DESCRIPTION	SIZE	MATERIAL/FINISH/HANDLE	FEATURES	INNER	MASTER	UPC CODE	BARCODE
501215	151TP	Screwdriver MegaPro	15 in 1	Tamperproof	Ratcheting Screwdriver	1	25	831044012151	

### MegaPro Ratcheting Screwdriver - 13 in 1

**BIT LOAD**



The MEGAPRO 13-in-1 ratcheting screwdriver features patent pending ZAD 8 Zinc Alloy SOLID-CORE ratchet that delivers over 225 inch lbs of torque strength. Precision 28-tooth ratchet design with rubberized cushion grip handle makes driving fasteners faster and easier. Loaded with 6 double end professional quality bits, this assortment of bit types and sizes provides the 13 most popular tips for driving screws. The shaft opening serves as a 1/4" hex driver!



ITEM #	MFG#	DESCRIPTION	SIZE	MATERIAL/FINISH/HANDLE	FEATURES	INNER	MASTER	UPC CODE	BARCODE
501244	211R2C36RD	Screwdriver MegaPro	13 in 1	Ratcheting	Ratcheting Screwdriver	1	25	831044012427	

C-Clamp Plier with Swivel Pads Soft Grip



ITEM #	MFG#	SIZE	INNER	MASTER	UPC CODE	BARCODE
506205	6205	7"	1	6	180611062052	
510201	10201	11"	1	6	180611102017	

Curved Jaw Plier with Soft Grip



ITEM #	MFG#	SIZE	INNER	MASTER	UPC CODE	BARCODE
510105	10105	10"	1	6	180611101058	

C Clamps, Vise Grip



ITEM #	MFG#	SIZE	INNER	MASTER	UPC CODE	BARCODE
80100017	17D	6"	1	5	38548000176	

Straight Jaw Locking Pliers



ITEM #	MFG#	SIZE	INNER	MASTER	UPC CODE	BARCODE
200304	7R-3	7" Straight	1	5	38548003047	
201304	10R-3	10" Straight	1	5	38548001043	

Long Nose Pliers, Vise Grip



ITEM #	MFG#	SIZE	INNER	MASTER	UPC CODE	BARCODE
201504	9LN	9"	1	5	38548015040	

Needle Nose Locking Plier with Soft Grip



ITEM #	MFG#	SIZE	INNER	MASTER	UPC CODE	BARCODE
509305	9305	7"	1	6	180611093056	

Welding Clamp, Vise Grip



ITEM #	MFG#	SIZE	INNER	MASTER	UPC CODE	BARCODE
80200025	25		1	1	38548000251	

Curved Jaw Pliers w/Wire Cutter, Vise Grip



ITEM #	MFG#	SIZE	INNER	MASTER	UPC CODE	BARCODE
200704	702L3	7"	1	5	38548007045	
200504	502L3	10"	5	25	38548005041	
200904	5WR	5"	1	5	38548009049	

Sheet Metal Tool, Vise Grip



ITEM #	MFG#	SIZE	INNER	MASTER	UPC CODE	BARCODE
80100023	23		1	1	38548000237	

Curved Jaw Locking Pliers



ITEM #	MFG#	SIZE	INNER	MASTER	UPC CODE	BARCODE
201304	7CR	7" Curved	1	5	38548013046	
201104	10CR	10" Curved	1	5	38548990699	



Tongue and Groove Plier



ITEM #	MFG#	SIZE	INNER	MASTER	UPC CODE	BARCODE
230127	426	6-1/2"	1	5	25582301277	
230067	420	9-1/2"	5	20	25582300676	



Auto. Groove Plier w/Soft Grip



ITEM #	MFG#	SIZE	INNER	MASTER	UPC CODE	BARCODE
520600	20600	6-1/2"	1	6	180611206005	
520900	20900	9-1/2"	1	6	180611209006	



Tongue and Groove Pliers - Large



ITEM #	MFG#	SIZE	INNER	MASTER	UPC CODE	BARCODE
230147	430	10"	5	20	25582301475	
230167	440	12"	5	20	25582301673	
230197	460	16"	5	20	25582301970	



Nippers

- Ideal for cutting nails
- Perfectly mated cutters
- Precision made of high carbon drop-forged steel
- Comfort grips
- High carbon drop forge heat treated steel



ITEM #	MFG#	SIZE	INNER	MASTER	UPC CODE	BARCODE
215607	357	7-1/2"	5	20	25582156075	
215621	358	8"	5	20	25582156211	



Pliers Snap Ring Nose

- Comfort grips
- Change from internal to external rings with a simple switch of the tab
- Includes 5 pairs of color coded interchangeable tips
- Heavy duty return spring



ITEM #	MFG#	SIZE	INNER	MASTER	UPC CODE	BARCODE
271111	927		5	20	25582566614	



Utility Tongue and Groove Plier



ITEM #	MFG#	SIZE	INNER	MASTER	UPC CODE	BARCODE
296017	GL10	9-1/2"	5	20	25582960177	



Wire Stripper Cutter

Strips, cuts, and crimps - this wiring tool does it all! Strips AWG wire (sizes 10, 12, 14, 16, 18, 20, and 22) and mm wire (sizes .80, 1.0, 1.3, 1.6, 2.0, and 2.6). Precision holes for wire stripping. Cuts machine bolts without damaging threads (sizes 4-40, 5-40, 6-32, 8-32, 10-32, and 10-24). Crimps both insulated and non-insulated connections. Scissor-type blades are precision ground and heat treated to hold their edge. Has the CHANNELLOCK BLUE comfort grips.



ITEM #	MFG#	SIZE	INNER	MASTER	UPC CODE	BARCODE
271131	908	8-1/4"	5	20	25582711311	



V-Jaw Tongue & Groove Plier



ITEM #	MFG#	SIZE	INNER	MASTER	UPC CODE	BARCODE
230187	442	12"	5	20	25582301871	



Wire Stripper Cutter

This wire stripper cutter has a safety latch and strips insulation fast with no damage to wire. Cuts copper wire cleanly. Blades are specifically heat treated for a long life. This tool features the Channel lock Blue comfort grips and are 100 % guaranteed against breakage and failure. Cuts copper wire sizes AWG 10, 12, 14, 16, 18, 20 cleanly.



ITEM #	MFG#	SIZE	INNER	MASTER	UPC CODE	BARCODE
271141	958	6-1/4"	5	20	25582711410	

Long Nose Pliers



- Electronically coated to prevent rusting
- Perfectly mated cutter, heat treated to hold its edge
- Cross hatching on Jaws
- Polished high carbon drop forge steel
- Comfort Grip

ITEM #	MFG#	SIZE	INNER	MASTER	UPC CODE	BARCODE
212197	317	7-1/2"	5	20	25582121974	
212207	318	8"	5	20	25582122070	

Linesman Pliers



- Right angle teeth grip in all directions for maximum bite and minimum wear
- Reinforced edge minimizes stress breakage
- Designed with double tongue and groove to prevent slipping
- V Jaws give more point of contact on objects
- Ergonomically designed offset head for greater leverage
- Electronically coated to prevent rusting
- Distinctive CHANNELLOCK BLUE comfort grips

ITEM #	MFG#	SIZE	INNER	MASTER	UPC CODE	BARCODE
214487	348	8-1/2"	5	20	25582144874	
214647	369	9"	5	20	25582146472	
214547	349	9"	5	20	25582145475	

Lap Joint Cutting Pliers



- Electronically coated to prevent rusting
- Perfectly mated cutter, heat treated to hold its edge
- Polished high carbon drop forged steel
- Comfort Grip

ITEM #	MFG#	SIZE	INNER	MASTER	UPC CODE	BARCODE
213327	337	7"	5	20	25582133274	
213361	338	8"	5	20	25582133618	
213797	447	7-3/4"	5	20	25582137975	

Crimping & Cutting Tool



- Designed to facilitate efficient crimping of wires
- Made from high carbon drop-forged steel
- Offers long lasting durability
- Channellock Blue comfort grips
- Made in USA

ITEM #	MFG#	SIZE	INNER	MASTER	UPC CODE	BARCODE
271197	909	9-1/2"	5	20	25582711977	

Cable Cutting Pliers



- Electronically coated to prevent rusting
- Perfectly mated cutter, heat treated to hold its edge
- Polished high carbon drop forged steel
- Comfort Grip

ITEM #	MFG#	SIZE	INNER	MASTER	UPC CODE	BARCODE
240347	911	9-1/2"	5	20	25582403476	





Compound Action Snips



Cuts Straight to Left

80058012



Cuts Straight to Right

80058018



Straight, Left, Right

80058021

ITEM #	MFG#	SIZE	INNER	MASTER	UPC CODE	BARCODE
80058012	M1R	Left cut, red	1	24	37103580122	
80058018	M2R	Right cut, green	1	24	37103580184	
80058021	M3R	Straight cut, yellow	1	24	37103580214	



Straight Pattern Snips

Cuts straight and wide curves (when trimming light gauge stock). For plumbing, heating, air conditioning and roofing trades.



ITEM #	MFG#	SIZE	INNER	MASTER	UPC CODE	BARCODE
80021389	A10N	11"	6	24	37103213891	
80021392	A11N	9-3/4"	6	24	37103213921	
80021393	A9N	12-1/2"	6	24	37103213938	



Multipurpose Snips



80012648

MultiMaster Snips Hi-Viz Handle Grips  
Combines long cut of thinners snips with the strength of compound action



80013640

Metal Wizz® Snips  
For cutting screening, hardware cloth, synthetic shingles, tile gutters

ITEM #	MFG#	SIZE	INNER	MASTER	UPC CODE	BARCODE
80012648	M300N	Multi Purpose	6	24	37103126481	
80013640	MPC3N	Multi purpose	6	24	37103580221	



Offset Snips



Cuts Straight to Left, Red Grips

ITEM #	MFG#	SIZE	INNER	MASTER	UPC CODE	BARCODE
80058337	M6R	Left Cut	1	24	37103583376	



Replacement Spring



80058092  
for the M1R,  
M2R, M3R



80058093  
for the M2R

ITEM #	MFG#	SIZE	INNER	MASTER	UPC CODE	BARCODE
80058092	P406V		1	6	37103580924	
80058093	P407V		1	6	37103580931	

### Thrifty Saw with Plastic Handle



Human engineered handle for comfortable, firm grip. Handle surrounds blade for lower center of gravity, maximizes cutting performance. Handle is ultrasonically welded to blade.

- 26" 8PT Cross Handsaw
- Tempered Steel Blade
- Handsaw Handle Welded To Blade
- Engineered Handle With Square/Mitre Feature
- Protective Full Length Sleeve



ITEM #	MFG#	SIZE	INNER	MASTER	UPC CODE	BARCODE
80015726	15-726	26"	6	6	76174157260	

### Finishing Saw



- A hard point toothed saw.
- The fine teeth give a smooth cut in a wide variety of wood based materials, aluminium, plastics and laminates.
- Fitted with a plastic handle which is strong and comfortable in use.
- Size 14in x 16PPI.



ITEM #	MFG#	SIZE	INNER	MASTER	UPC CODE	BARCODE
80000595	300-14-16PPI-HP	14" x 16T	1	4	7311518005955	

### PrizeCut Handsaw Hardpoint



- Professional handsaw for cutting all types of wood.
- Universal teething with Hard point-teeth for long lasting sharpness.
- Screwed one-piece plastic handle.

ITEM #	MFG#	SIZE	INNER	MASTER	UPC CODE	BARCODE
80003439	NP-22-U7/8-HP	22" x 8T	1	10	7311518034399	

### Professional Rip/Crosscut Handsaw



- "XT" tooth line for rip and crosscut
- "Razor" sharp heat induction hardening
- Black ergonomic handle

ITEM #	MFG#	SIZE	INNER	MASTER	UPC CODE	BARCODE
80014092	2500-22XT-HP	22" x 9 XT	1	4	7311518140922	

### Dovetail Saw



- High performance tenon saw with hardened tooth tips.
- Teeth precision ground and set
- Universal serrations for sawing with and against the grain
- Wooden handle
- Professional dovetail saw for wood and plastic materials.
- Fine universal toothting with hard point-teeth and light steel back for rigidity.

ITEM #	MFG#	SIZE	INNER	MASTER	UPC CODE	BARCODE
80026354	PC10-DTR	10"	1	10	7311518263546	

### Prof Cut Tenon Saw



Professional tenon saw for fine and medium thick materials, specially adapted for cutting of small-section timber and mitre guide sawing. Hard point teeth for long lasting sharpness. Heavy steel back for rigidity and accurate cutting. Screwed, one-piece, two-component plastic handle

ITEM #	MFG#	SIZE	INNER	MASTER	UPC CODE	BARCODE
80026344	PC-12-TEN	12"	1	4	7311518263447	



### Drywall Jab Saw With Heavy-Duty Steel Blade

Cuts drywall materials.

80018820 - Wood handle



Cuts drywall, PVC pipe, wood and similar materials.

80018828 - Ergo-Grip



ITEM #	MFG#	SIZE	INNER	MASTER	UPC CODE	BARCODE
80018820	1820	6"	10	100	66395188204	
80018828	18828	6"	5	60	66395188280	



### Coping Saw

- Frame coping saw for professional applications
- Hardened, tempered edge for clean, controllable cutting action
- 6-3/8-inch blade made from highest-grade high-carbon steel
- Hardwood handle for long-lasting durability and comfort
- Deep Throat

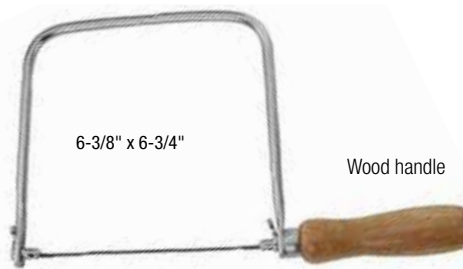

ITEM #	MFG#	SIZE	INNER	MASTER	UPC CODE	BARCODE
80015106	15-106	6-3/8" x 6-3/4"	6	6	76174151060	



### Bow Saws



ITEM #	MFG#	SIZE	INNER	MASTER	UPC CODE	BARCODE
80022934	10-21-51-KP	21" #51 blade	1	5	7311518229344	
80022935	18925	24" #51 blade	1	5	7311518229351	



### Bow Saw Blades



ITEM #	MFG#	SIZE	INNER	MASTER	UPC CODE	BARCODE
80000390	51-21	12"	1	10	7311518003906	
80000391	51-24	21"	1	10	7311518003913	
80000392	51-30	24"	1	10	7311518003920	



### Mini Hacksaw



ITEM #	MFG#	SIZE	INNER	MASTER	UPC CODE	BARCODE
80020807	20-807	6"	6	36	76174208078	



### Mini Hacksaw



ITEM #	MFG#	SIZE	INNER	MASTER	UPC CODE	BARCODE
80020807	20-807	6"	6	36	76174208078	
80001752	218	6"	1	10	7311518017521	
80025582	208	10"	1	5	7311518255824	

Short Point Industrial Flooring Knife



ITEM #	MFG#	SIZE	INNER	MASTER	UPC CODE	BARCODE
80005005	C-5		10	100	66395050051	

Roofing Knife With Birch Handle Without Finger Guard



Used in roofing installations to cut paper



ITEM #	MFG#	SIZE	INNER	MASTER	UPC CODE	BARCODE
80014110	R-1-W		10	100	66395141100	

Long Point Industrial Flooring Knife



ITEM #	MFG#	SIZE	INNER	MASTER	UPC CODE	BARCODE
80005001	C-1		10	100	66395050013	

Leather & Rubber Knife



ITEM #	MFG#	SIZE	INNER	MASTER	UPC CODE	BARCODE
80014005	L-5		10	200	66395140059	

Laminate Cutter With Plastic Handle



High-carbon steel blade, heat-treated, tempered and painted, cuts laminate materials.

ITEM #	MFG#	SIZE	INNER	MASTER	UPC CODE	BARCODE
80005006	C6		10	80	66395050068	

Roofing Knife With Plastic Handle And Finger Guard.



Used in roofing installations to cut paper

ITEM #	MFG#	SIZE	INNER	MASTER	UPC CODE	BARCODE
80014100	R-1		10	100	66395141001	

Industrial Knife With Tapered Point



Used for various industrial applications, but also useful for other situations.

ITEM #	MFG#	SIZE	INNER	MASTER	UPC CODE	BARCODE
80014006	L-6		10	200	66395140066	

Utility Knife With Fixed Blade



ITEM #	MFG#	SIZE	INNER	MASTER	UPC CODE	BARCODE
80008100	U-1-C		10	100	66395081000	



Utility Knives



Packed with 3 heavy-duty blades in the handle. Die-cast zinc metal body. New ergonomic profile for comfort. Overlapping joint for safety. Cuts linoleum, wood, paper, plastic, leather, drywall and carpet

ITEM #	MFG#	SIZE	INNER	MASTER	UPC CODE	BARCODE
80008300	U-3-C		10	100	66395083004	

Utility Knives Blades



ITEM #	MFG#	SIZE	INNER	MASTER	UPC CODE	BARCODE
80008011	U-1-B	5pk	10	200	66395080119	

Heavy Duty Utility Knife



A super heavy-duty knife with double notched blade location for added security. Easy blade change using solid brass notched wheel. Complete with five heavy duty blades and polypropylene protective holster.

ITEM #	MFG#	SIZE	INNER	MASTER	UPC CODE	BARCODE
80072421	10-550m		12	12	76174724219	

Utility Knife Blades

**Regular Duty Utility Blades**

Regular-duty utility blade for light sheet materials, paper and cardboard

80011911



**Heavy Duty Utility Blades**

Engineered for general-purpose cutting

80011921



ITEM #	MFG#	SIZE	INNER	MASTER	UPC CODE	BARCODE
80011911	11-911	5pk	10	200	76174119114	
80011921	11-921	5pk	10	200	76174119213	

Classic 99® Retractable Utility Knife



The Stanley 16-inch Classic 99 Retractable Utility Knife starts sharper and stays sharper than standard heavy-duty blades. This knife features a patented interlocking nose to hold the blade securely. The three-position, retractable blade can be stored in the handle. This knife includes three blades.

ITEM #	MFG#	SIZE	INNER	MASTER	UPC CODE	BARCODE
80110099	10-099		6	36	76174100990	

Hook Utility Blades

**Large Hook Blade**

Deeper hook for cutting thicker materials



ITEM #	MFG#	SIZE	INNER	MASTER	UPC CODE	BARCODE
80011983	11-983	5pk	10	200	76174119831	



Fixed Blade Utility Knife



The Stanley 5-1/2-Inch 299 Interlock Fixed Blade Utility Knife starts sharper and stays sharper than standard heavy-duty blades. This knife features a patented interlocking nose for safety. The contoured handle has a slip-resistant grip and integrated blade storage.

ITEM #	MFG#	SIZE	INNER	MASTER	UPC CODE	BARCODE
80010299	10-299		6	36	76174102994	



Heavy Duty Utility Blades with Dispenser

**Hook Blade**



80000534



80011992

ITEM #	MFG#	SIZE	INNER	MASTER	UPC CODE	BARCODE
80000534	11-983A	100pk	4	24	76174005349	
80011992	11-921A	100pk	4	24	76174119923	

Snap off blade knife small - 100pk



ITEM #	MFG#	SIZE	INNER	MASTER	UPC CODE	BARCODE
80083245	0	100pk	1	10	65169832459	

Heavy-Duty Ratchet-Lock Utility Knife with Rubber Grip Insert - 18mm



ITEM #	MFG#	SIZE	INNER	MASTER	UPC CODE	BARCODE
80060004	L1	Heavy Duty	6	120	91511600049	
80060006	L2	Heavy Duty	6	120	91511600063	

180 Standard Cutter w/3 Blades



1/2" All Steel Frame, Pocket Holder & Blade Snapper - 9mm

ITEM #	MFG#	SIZE	INNER	MASTER	UPC CODE	BARCODE
80160001	180		6	120	91511600018	

Extra Heavy-Duty Ratchet-Lock Utility Knife - 25mm



ITEM #	MFG#	SIZE	INNER	MASTER	UPC CODE	BARCODE
80060011	H1	Heavy Duty	6	120	91511600117	

Plastic / Laminate Heavy-Duty Cutter



ITEM #	MFG#	SIZE	INNER	MASTER	UPC CODE	BARCODE
80060012	PC-L	Heavy Duty	6	120	91511400946	

HandSaver® Cushion Grip Extra HD Ratchet-Lock Utility Knife - 25mm



This extra heavy-duty knife is part of the HandSaver® Knife Series featuring anti-slip cushion grip handles. HandSaver® handles provide premium comfort, and maximum performance.

ITEM #	MFG#	SIZE	INNER	MASTER	UPC CODE	BARCODE
80060026	NH1	Heavy Duty	6	120	91511600261	

Self-Retracting Safety Knife



Revolutionary spring-retractable safety cutter has a heavy-duty springactivated blade that automatically retracts the instant the blade loses contact with the cutting surface, reducing injuries in the workplace.

ITEM #	MFG#	SIZE	INNER	MASTER	UPC CODE	BARCODE
80040062	SK4		6	120	91511400625	

Heavy-Duty Carpet Cutter - 18mm



This sure-grip heavy-duty utility cutter features a ratchet wheel blade lock and anti-slip rubber grip insert. High quality snap-off blade provides unparalleled sharpness and superior edge retention

ITEM #	MFG#	SIZE	INNER	MASTER	UPC CODE	BARCODE
80060007	OL	Heavy Duty	6	120	91511600070	

Extra Heavy-Duty Ratchet-Lock Utility Knife - 25mm



This extra heavy-duty knife is part of the X OLFA Design Series™, a powerful line of anti-slip grip cutting tools combining exceptional performance with innovation.

ITEM #	MFG#	SIZE	INNER	MASTER	UPC CODE	BARCODE
80060085	XH-1	Heavy Duty	6	72	91511600858	

Extra H.D. Utility Knife



ITEM #	MFG#	SIZE	INNER	MASTER	UPC CODE	BARCODE
80060708	LA-XS		6	36	91511706076	



Extra Heavy-Duty Snap-off Blades

1/2" (13mm) Wide Blade

ITEM #	MFG#	SIZE	INNER	MASTER	UPC CODE	BARCODE
80060014	AB10B	10pk	6	240	91511600148	
80060015	AB50B	50pk	6	120	91511600155	



Heavy-Duty Snap-off Blade Packs

3/4" (18mm) Wide Blade

ITEM #	MFG#	SIZE	INNER	MASTER	UPC CODE	BARCODE
80060017	LB10B	10pk	6	240	91511600179	
80060019	LB50B	50pk	6	36	91511600193	



3/4" (18mm) Wide Blade



UltraMax® Heavy-Duty Snap-off Blades

ITEM #	MFG#	SIZE	INNER	MASTER	UPC CODE	BARCODE
80060707	LBB-5B	5pk	6	240	91511607079	
80060036	LBB10B	10pk	6	240	91511600360	
80060037	LBB-50B	50px	1	6	91511600377	



1" (25mm) Wide Blade



Extra Heavy-Duty Snap-off Blade

ITEM #	MFG#	SIZE	INNER	MASTER	UPC CODE	BARCODE
80060020	HB5B	5pk	6	120	91511600209	
80060031	HB20	20pk	6	36	91511600315	

UltraMax® Extra Heavy-Duty Snap-off Blades

1" (25mm) Wide Blade



Heavy-Duty Plastic/Laminate Blades



ITEM #	MFG#	SIZE	INNER	MASTER	UPC CODE	BARCODE
80050127	HBB-20B	20pk	6	36	91511501278	

ITEM #	MFG#	SIZE	INNER	MASTER	UPC CODE	BARCODE
80060022	PB800	3pk	6	240	91511600223	



Trapezoid Safety Blade



Trapezoid safety knife replacement blade helps reduce injuries in the workplace.

Use with #80040062

ITEM #	MFG#	SIZE	INNER	MASTER	UPC CODE	BARCODE
80060024	SKB-2/10B	10pk	6	120	91511600247	



Roofing HD. Snap-off Hook Blade

3/4" (18mm) Wide Blade



ITEM #	MFG#	SIZE	INNER	MASTER	UPC CODE	BARCODE
80201072	LH20B	20pk	6	120	67586010724	



Utility Blade Snap Off - Xtra HD 40/pk

1" (25mm) Wide Blade

ITEM #	MFG#	SIZE	INNER	MASTER	UPC CODE	BARCODE
80022020	0	40pk	4	24	9151220209	



HD Utility Blade Snap Off - 100/pk

3/4" (18mm) Wide Blade



ITEM #	MFG#	SIZE	INNER	MASTER	UPC CODE	BARCODE
80045003	0	100pk	1	4	91511450033	

Scraper Tool w/Wood Handle



ITEM #	MFG#	SIZE	INNER	MASTER	UPC CODE	BARCODE
80003010	W-10	1" x 5 7/8"	10	100	66395030107	
80003014	W-14	2 1/2" x 14"	10	80	66395030145	
80003134	W-1 3/4	1 3/4" x 7 7/8"	10	120	66395031340	

Scraper Tool w/  
Wood Handle



ITEM #	MFG#	SIZE	INNER	MASTER	UPC CODE	BARCODE
80003212	W-2 1/2	2 1/2" x 8 1/2"	10	100	66395032125	
80004022	CW-2 1/2-B	1/2B	20	200	66395040229	
80004034	CW-1 3/4-B	3/4B	20	200	66395040342	
80004110	CW-10-B	1/2B	10	100	66395041103	

Retractable Scrapers



Retractable Metal Razor Scraper

Scrapers and cleans windows and various surfaces.  
80012300



Plastic Retractable Razor Scraper (Carded)

80012100



Plastic Retractable Razor Scraper

80012200



ITEM #	MFG#	SIZE	INNER	MASTER	UPC CODE	BARCODE
80012300	RS-300		20	200	66395123007	
80012100	RS-100		20	200	66395121003	
80012200	RS-200	5pc	20	160	66395122000	

Metal Single Edge Razor Scraper



80012001

Shave hook Scraper With Wood Handle



80003902

ITEM #	MFG#	SIZE	INNER	MASTER	UPC CODE	BARCODE
80012001	RS-1		20	200	66395120013	
80003902	2902		10	100	66395039025	

Extra Heavy-Duty Scraper



Longer handle accommodates two-handed use for more leverage on larger, more demanding removal jobs.

ITEM #	MFG#	SIZE	INNER	MASTER	UPC CODE	BARCODE
80040076	BSR-300	12"	3	30	91511400762	

Drywall Wallpaper and Floor Scraper



80013320



80013321

3pk Replacement Blades for Drywall Scraper

ITEM #	MFG#	SIZE	INNER	MASTER	UPC CODE	BARCODE
80013320	13320		5	60	66395133204	
80013321	13321	3pc	10	100	66395133211	

Retractable Razor Scraper with Plastic Blades



ITEM #	MFG#	SIZE	INNER	MASTER	UPC CODE	BARCODE
80112360	12360		20	160	66395123601	

Replacement Blades



Metal



80012010

80009212

Plastic



80012363

ITEM #	MFG#	SIZE	INNER	MASTER	UPC CODE	BARCODE
80012010	RS-2-B	5pk	20	400	66395120105	
80009212	1212	100pk	10	50	66395092129	
80012363	12363	5pc	20	400	66395123632	

**STANLEY**

Surform Pocket Plane

- Designed for one-handed use
- Ideal for end-grain work, sheet rocking and smoothing edges of laminates
- Manufactured with a metallic gray, die-cast alloy body
- Includes thumbscrew blade tension for quick blade replacement
- Fitted with a replaceable (5-1/2"/140mm) fine cut blade



**STANLEY**

Pocket Fine Cut Replacement Blade

Produces a fine finish on hard woods, end grains and soft metals

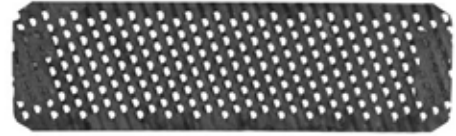

ITEM #	MFG#	SIZE	INNER	MASTER	UPC CODE	BARCODE
80021399	21-399	5-1/2"	4	24	76174213997	

ITEM #	MFG#	SIZE	INNER	MASTER	UPC CODE	BARCODE
80021398	21-398	5-1/2"	4	24	76174213980	

**STANLEY**

Smoothing Bench Plane

- Cutter adjusts for depth and alignment, offering precise control
- Quick-release cam-lock makes iron removal easy



**STANLEY**

Surform® Flat File – Regular Cut Blade



Superb tool for use as a rasp on wood, plastic, soft metals and many other materials

ITEM #	MFG#	SIZE	INNER	MASTER	UPC CODE	BARCODE
80012204	12-204	9-1/4"	6	6	76174122046	
80012904	12-904	9"	6	6	76174129045	

ITEM #	MFG#	SIZE	INNER	MASTER	UPC CODE	BARCODE
80021295	21-295	10"	6	6	76174212952	

**STANLEY**

Adjustable Lever Block Plane

- Machined sides
- Cutter rests at a 21° angle, ideal for cross-grain planing
- Cutter is fully adjustable for depth of cut and alignment
- Gray, cast-iron base with precision-ground sides and bottom
- Durable epoxy coating provides long-lasting protection



**STANLEY**

Pocket Fine Cut Replacement Blade



Produces a fine finish on hard woods, end grains and soft metals

ITEM #	MFG#	SIZE	INNER	MASTER	UPC CODE	BARCODE
80012247	12-247	6-5/8"	6	6	76174122473	

ITEM #	MFG#	SIZE	INNER	MASTER	UPC CODE	BARCODE
80021299	21-299	10"	6	36	76174212990	
80021293	21-293	10"	4	24	76174212938	

**STANLEY**

Regular Block Plane

Hardened, tempered steel gives precision-ground cutter edge durability Fully machined and polished double-iron cutter and lever



Lever Bar Scraper



ITEM #	MFG#	SIZE	INNER	MASTER	UPC CODE	BARCODE
80012220	12-220	7"	6	6	76174122206	

ITEM #	MFG#	SIZE	INNER	MASTER	UPC CODE	BARCODE
80003110	US-10-C	10"	5	30	66395031104	

Handy File



ITEM #	MFG#	SIZE	INNER	MASTER	UPC CODE	BARCODE
80006001	T06601	8"	6	90	37103060013	

Slim Taper File without Handle, Carded



ITEM #	MFG#	SIZE	INNER	MASTER	UPC CODE	BARCODE
80021792	21866N	6"	6	360	37103217929	

Plastics File w/Handle



ITEM #	MFG#	SIZE	INNER	MASTER	UPC CODE	BARCODE
80021690	21690	8"	6	72	37103216908	

Extra Slim Taper File without Handle, Carded



ITEM #	MFG#	SIZE	INNER	MASTER	UPC CODE	BARCODE
80021795	21873N	6"	6	360	37103217950	

Woodcraft Rasp, Carded



ITEM #	MFG#	SIZE	INNER	MASTER	UPC CODE	BARCODE
80021987	23859N	8"	6	96	37103219879	

Round Bastard Cut without Handle, Carded



ITEM #	MFG#	SIZE	INNER	MASTER	UPC CODE	BARCODE
80021846	21846	6"	1	6	37103218469	
80021853	21853	8"	6	300	37103218537	

Axe File



ITEM #	MFG#	SIZE	INNER	MASTER	UPC CODE	BARCODE
80006706	06706N	8"	6	96	37103067067	

Round Chainsaw File



ITEM #	MFG#	SIZE	INNER	MASTER	UPC CODE	BARCODE
80023861	23861	13/64 x 8"	6	300	37103238610	
80001630	T01630	5/32 x 6"	3	48	37103016300	
80001765	T01765	3/16 x 8" Round	6	300	37103017659	
80001888	T01888	7/32 x 8"	3	48	37103018885	



Tungsten File



ITEM #	MFG#	SIZE	INNER	MASTER	UPC CODE	BARCODE
80002375	T02375	5-1/4"	6	360	37103023759	



Flat Bastard Cut without Handle, Carded



ITEM #	MFG#	SIZE	INNER	MASTER	UPC CODE	BARCODE
80021862	21862	8"	6	120	37103218629	



Mill Bastard Cut without Handle, Carded



ITEM #	MFG#	SIZE	INNER	MASTER	UPC CODE	BARCODE
80021825	21825	6"	6	360	37103218254	
80021832	21832N	8"	6	72	37103218322	
80021839	21839N	10"	6	96	37103218391	



Half Round Bastard Cut without Handle, Carded



ITEM #	MFG#	SIZE	INNER	MASTER	UPC CODE	BARCODE
80021857	21857N	8"	1	6	37103218575	

File Handle PH2 Red Plastic with Threaded Insert



Screw-on Plastic File Handle



ITEM #	MFG#	SIZE	INNER	MASTER	UPC CODE	BARCODE
80018118	21493	PH2, 3-3/4"	1	12	37103181183	
80014338	21484	PH1, 3-1/2"	1	12	37103143389	
80047751	21502	PH3, 3-3/4"	1	12	37103477514	



Tube Cutter Ratcheting

ITEM #	MFG#	SIZE	INNER	MASTER	UPC CODE	BARCODE
84013921	M7540	1/4 to 7/80d	1	6	26508139219	



Scratch Awl - Wood Handle



ITEM #	MFG#	SIZE	INNER	MASTER	UPC CODE	BARCODE
80069122	69-122	6-1/16"	6	72	76174691221	

Masonry Chisels



A carbon steel blade, with protective grip and anti-mushrooming head, used to smooth the rippled surface left by scuffing. Sometimes known as an edge in chisel.

ITEM #	MFG#	SIZE	INNER	MASTER	UPC CODE	BARCODE
80011600	1235	2-1/2"	1	3	748147116009	
80011011	1237	3"	1	3	748147110113	
80011012	1237	4"	1	3	748147110120	
80011013	1237	4-1/2"	1	3	748147110137	

Concrete Point Chisel with Grip



An invaluable tool for breaking up concrete and paving slabs by hand. A forged and ground point, provide a concentrated force ideal for localized shattering.

ITEM #	MFG#	SIZE	INNER	MASTER	UPC CODE	BARCODE
80011301	582PWG	10 x 3/4"	1	3	748147113015	

Square Shank Head Nail Set



- Alloy steel is hardened and tempered
- Cupped, chamfered tip
- Square head prevents rolling when set down

ITEM #	MFG#	SIZE	INNER	MASTER	UPC CODE	BARCODE
80058111	58-111	1/32"	6	72	56527581119	
80058112	58-112	2/32"	6	72	56527581126	
80058113	58-113	3/32"	6	72	56527581133	
80058114	58-114	4/32"	6	72	56527581140	

Brick Chisels



ITEM #	MFG#	SIZE	INNER	MASTER	UPC CODE	BARCODE
80011250	2700	9 x 2-1/4"	1	6	748147112506	

Wood Chisels



ITEM #	MFG#	SIZE	INNER	MASTER	UPC CODE	BARCODE
80012025	87	3/8"	1	6	748147120259	
80012026	87	1/2"	1	6	748147127043	
80012027	87	5/8"	1	6	748147120273	
80020280	87	3/4"	1	6	748147127067	
80012030	87	1"	1	6	748147127081	
80012031	87	1-1/4"	1	6	748147127098	

Wire Brush Block



- 6 rows of tempered steel bristles
- Wood block
- Ideal for tough jobs that require plenty of pressure

ITEM #	MFG#	SIZE	INNER	MASTER	UPC CODE	BARCODE
87050515	515	7-1/2"	1	20	65681505152	

Mini Bar Clamp



ITEM #	MFG#	SIZE	INNER	MASTER	UPC CODE	BARCODE
80000546	546ZR	7-1/2"	1	5	38548005461	

Bar Clamp



ITEM #	MFG#	SIZE	INNER	MASTER	UPC CODE	BARCODE
80010370	512QCN	12"7-1/2"	1	5	38548103709	
80010372	518QCN	18"7-1/2"	1	5	38548103723	
80010373	524QCN	24"7-1/2"	1	5	38548103730	